



Amodini
Crafting with Care



Style meets Sensibility

“ Furniture must have a personality as well as be beautiful ”

CRAFTSMANSHIP AT ITS BEST

Amodini, established in 2001 is a multidiscipline Interior Designing firm founded on a commitment to client service and quality design. We have wide range of unique Ideas that suit every taste & every budget.

We empathies our clients with our expertise, efforts & well equipped team of Electricians, Plumbers, arpenters, Masons, Painters, Upholsters, Site Supervisors etc. Subsequently Client's time is saved that leads to lots of business Savings to our clients with mutual benefits. Our Products also reflect the same alike Qualities that suit the Celebrities.



Office Workstations

A workstation is an area where an individual performs daily work-related tasks. For example, in an office setting this might include a desk, writing area, computer, and storage area for documents. It is the purpose of the workstation to provide the user with space to carry out their typical work duties. It allows a person to utilize an organized area in order to increase the efficiency of their job tasks. A workstation can include specialized equipment and tools that an employee requires to perform their job duties. These tools and equipment should be placed in an organized fashion within the workstation in order to make them readily accessible to the employee without an undue physical strain. This allows the employee to efficiently perform daily job duties faster and more efficiently. Certain aspects of the workstation can be specifically designed to ergonomically suit a particular staff member, or group of employees. By designing the area to fit a particular person, it can greatly increase that worker's efficiency. Good ergonomic design also helps to ensure the well-being and safety of the staff.





Workstation



Executive Cabin Desk



Meeting - Conference Table



Storage



Seating



Turnkey Interiors

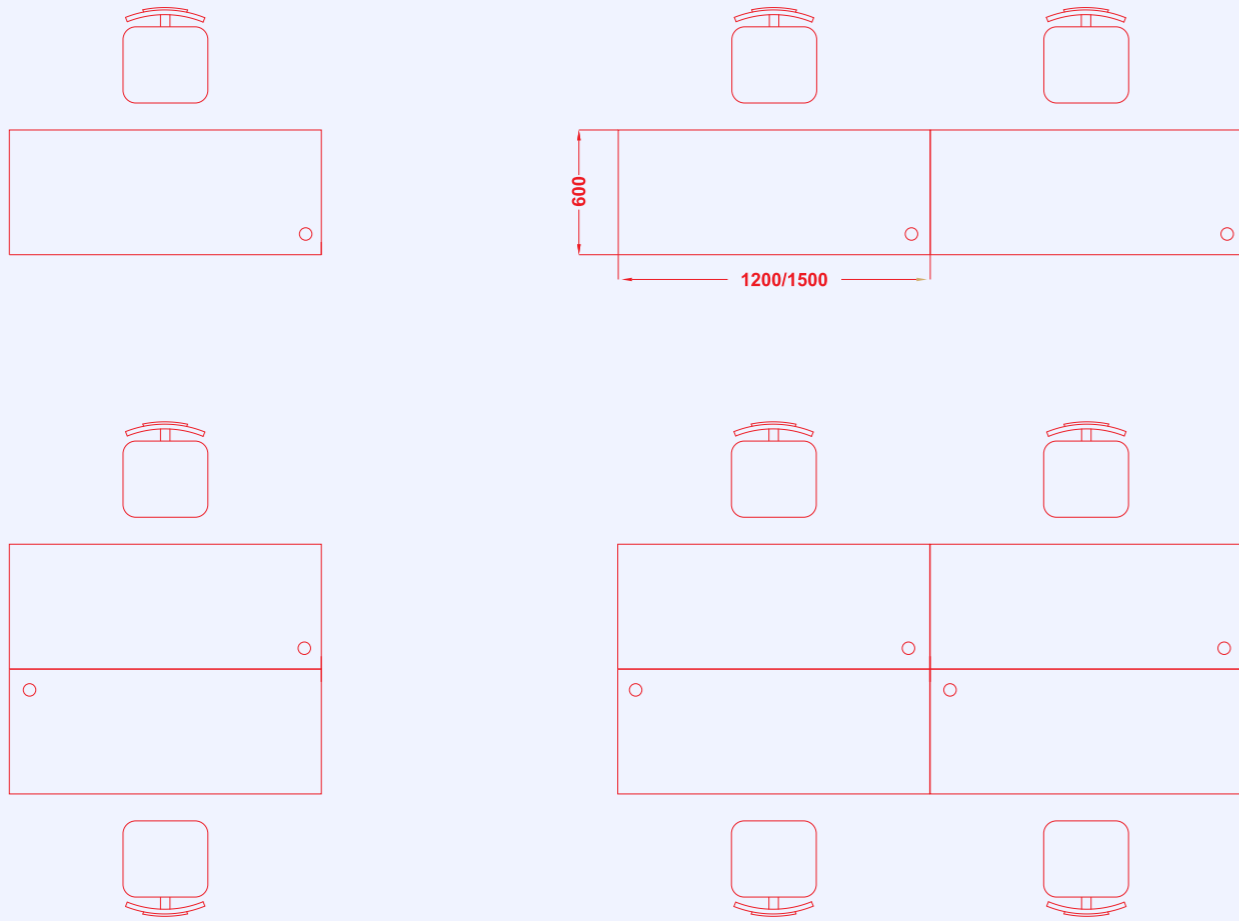

CLUSTER

Amodini Workstation

STYLE

Open Desking

CATEGORY

A-OD-01

* Dimensions in MM

For more information visit us at:
www.amodinisystems.com

PRODUCT DESCRIPTION

WORKTOP
25MM THICK PL-PB/MDF

LEGS
X50MM / 40X40MM CRCA POWDER COATED

WIRE MANAGEMENT
CRCA POWDER COATED/ PL-PB

PRIVACY SCREENS
MAGNETIC FABRIC / LACQUERED GLASS
/ ACRYLIC / 32MM ALUMINUM PANEL

MODESTY
MS PERFORATED/ PL-PB



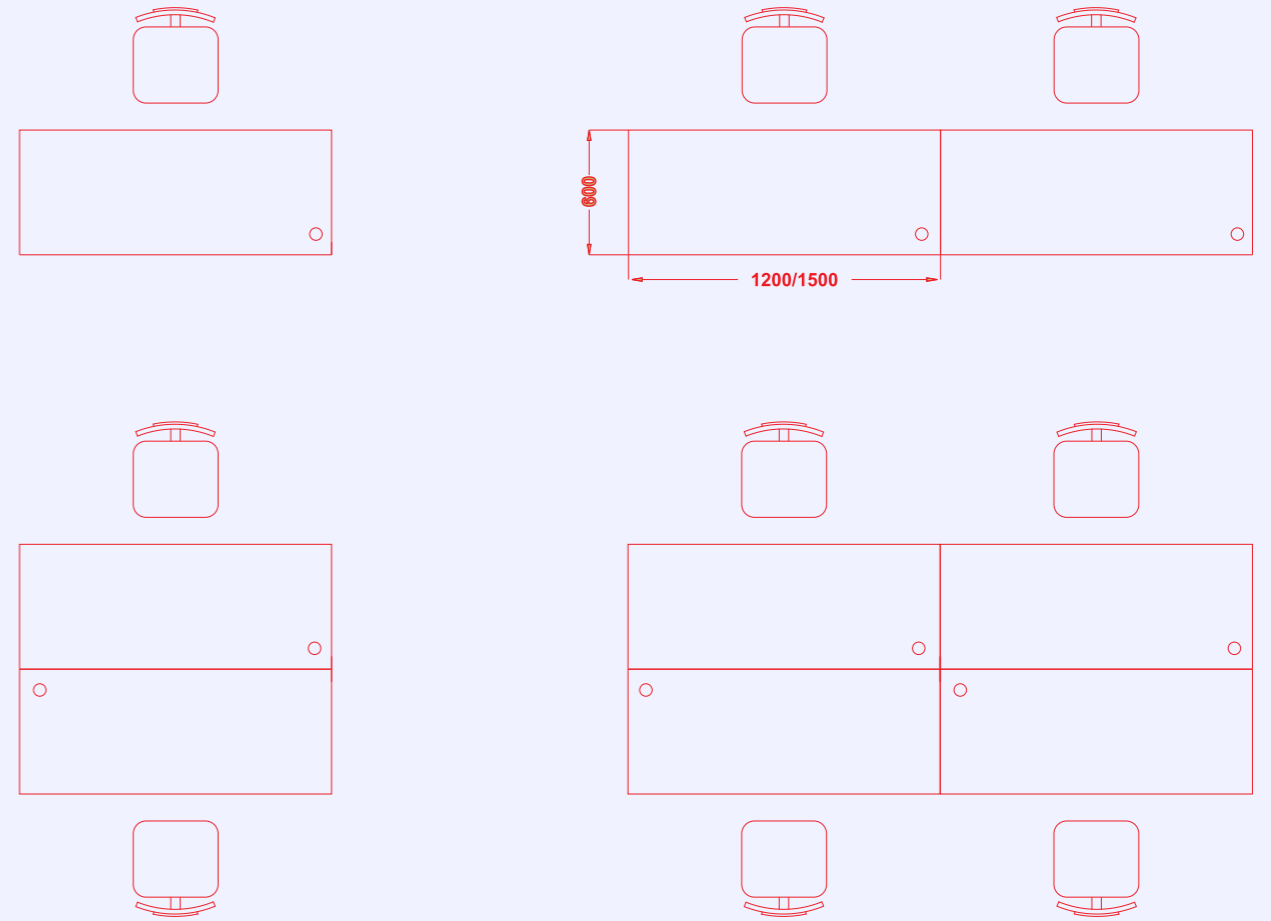

PRODUCT DESCRIPTION

WORKTOP
25MM THICK PL-PB/MDF

LEGS
X50MM / 40X40MM CRCA POWDER COATED

WIRE MANAGEMENT
CRCA POWDER COATED/ PL-PB

PRIVACY SCREENS
MAGNETIC FABRIC / LACQUERED GLASS
/ ACRYLIC / 32MM ALUMINUM PANEL

MODESTY
MS PERFORATED/ PL-PB

* Dimensions in MM

For more information visit us at:
www.amodinisystems.com

CLUSTER
Amodini Workstation

STYLE
Open Desking

CATEGORY
A-OD-02

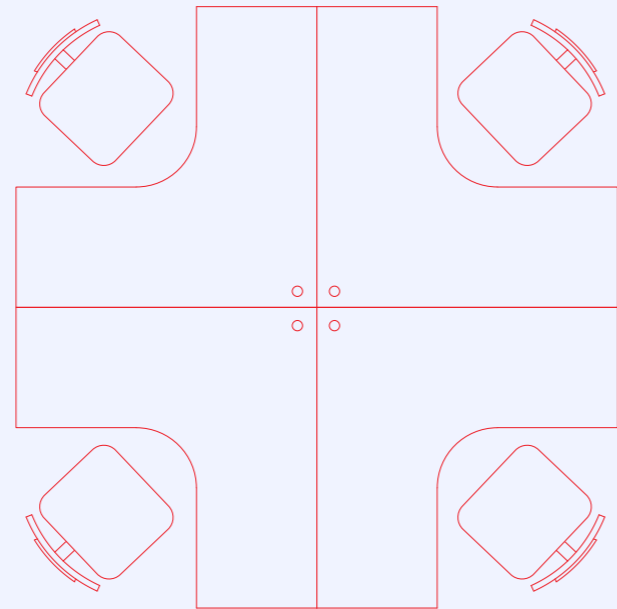
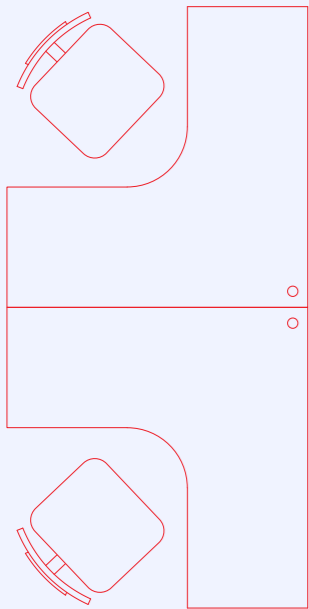
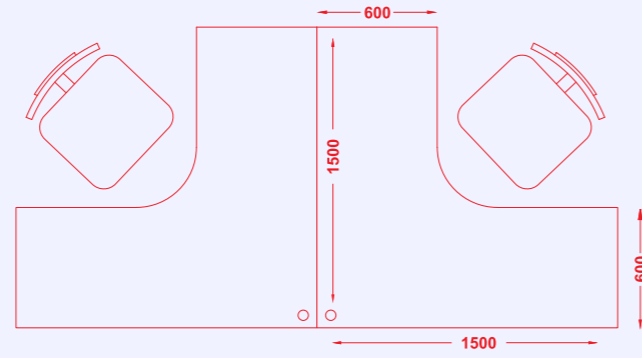
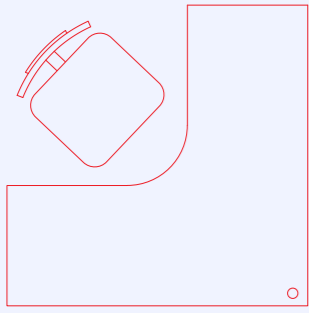

CLUSTER

Amodini Workstation

STYLE

Open Desking

CATEGORY

A-OD-03

* Dimensions in MM

For more information visit us at:
www.amodinisystems.com

PRODUCT DESCRIPTION

WORKTOP

25MM THICK PL-PB/MDF

LEGS

X50MM / 40X40MM CRCA POWDER COATED

WIRE MANAGEMENT

CRCA POWDER COATED/ PL-PB

PRIVACY SCREENS

MAGNETIC FABRIC / LACQUERED GLASS
/ ACRYLIC / 32MM ALUMINUM PANEL

MODESTY

MS PERFORATED/ PL-PB



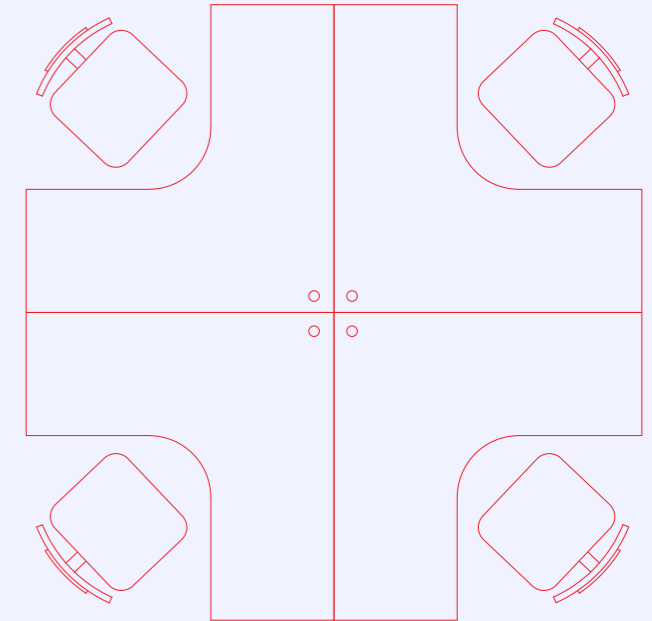
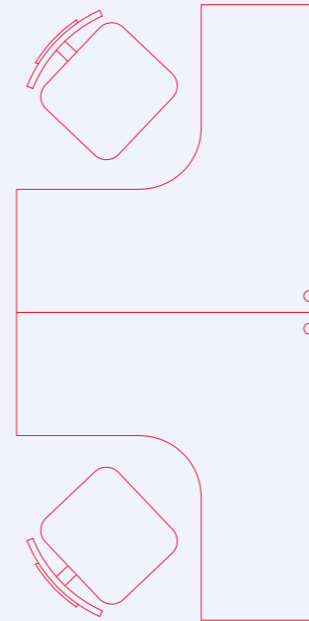
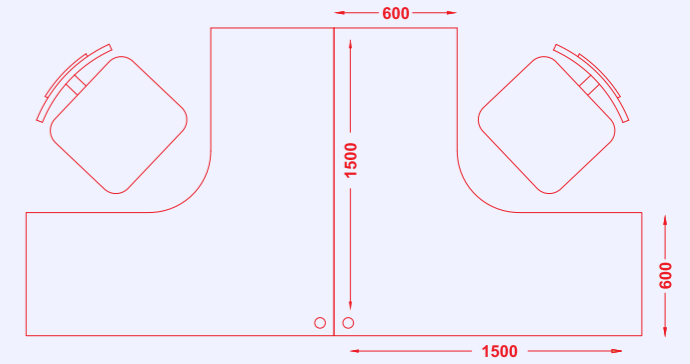
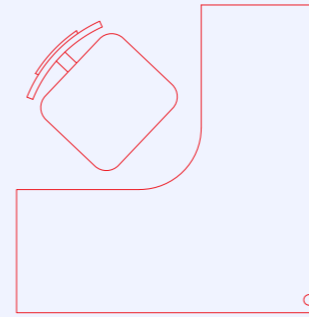

PRODUCT DESCRIPTION

WORKTOP
25MM THICK PL-PB/MDF

LEGS
X50MM / 40X40MM CRCA POWDER COATED

WIRE MANAGEMENT
CRCA POWDER COATED/ PL-PB

PRIVACY SCREENS
MAGNETIC FABRIC / LACQUERED GLASS
/ ACRYLIC / 32MM ALUMINUM PANEL

MODESTY
MS PERFORATED/ PL-PB

* Dimensions in MM

For more information visit us at:
www.amodinisystems.com

CLUSTER
Amodini Workstation

STYLE
Open Desking

CATEGORY
A-OD-04

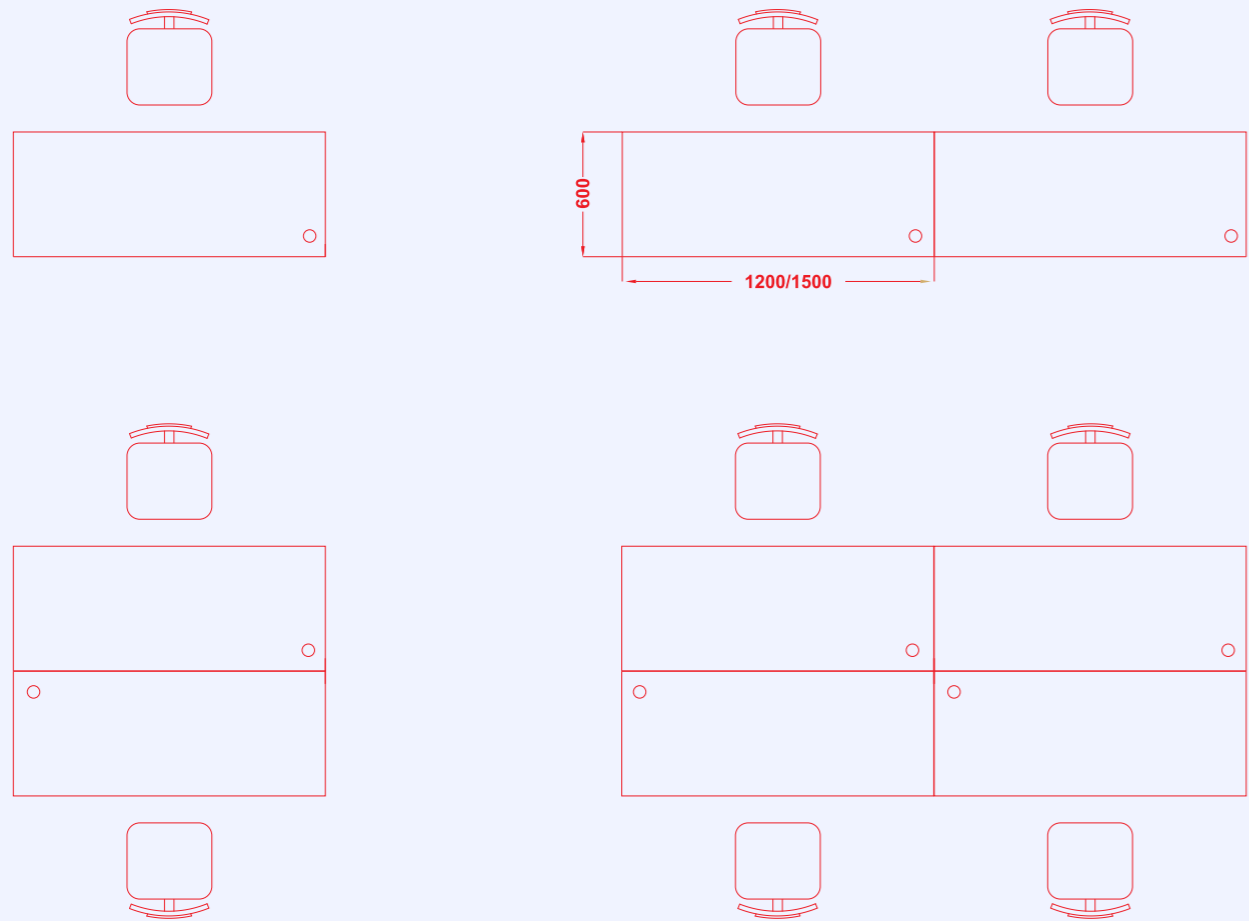

CLUSTER
Amodini Workstation

STYLE
Open Desking

CATEGORY
A-OD-05

PRODUCT DESCRIPTION

- WORKTOP**
25MM THICK PL-PB/MDF

- LEGS**
X50MM / 40X40MM CRCA POWDER COATED

- WIRE MANAGEMENT**
CRCA POWDER COATED/ PL-PB

- PRIVACY SCREENS**
MAGNETIC FABRIC / LACQUERED GLASS / ACRYLIC / 32MM ALUMINUM PANEL

- MODESTY**
MS PERFORATED/ PL-PB

* Dimensions in MM

For more information visit us at:
www.amodinisystems.com

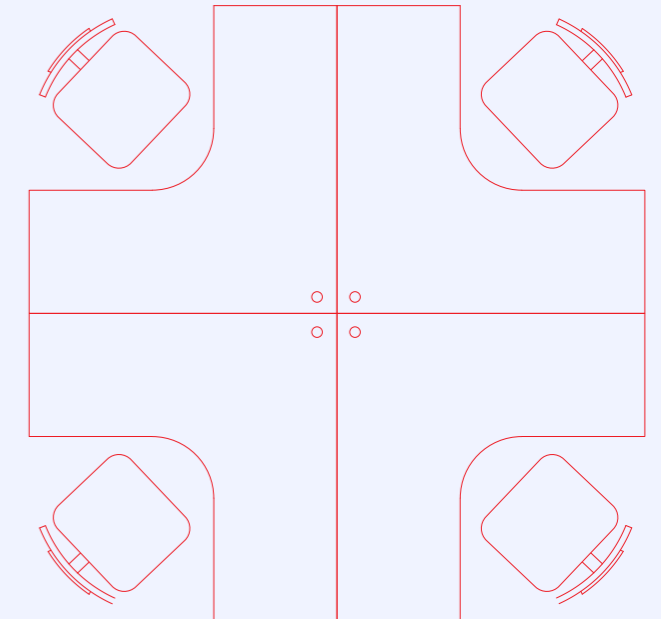
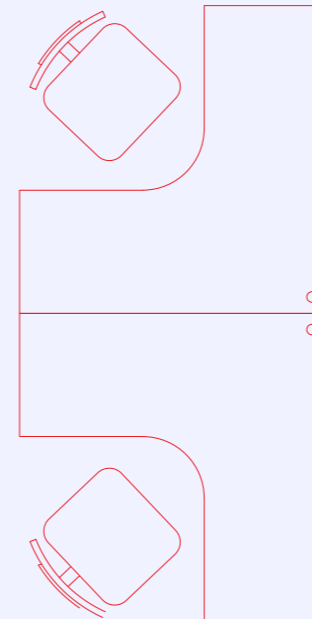
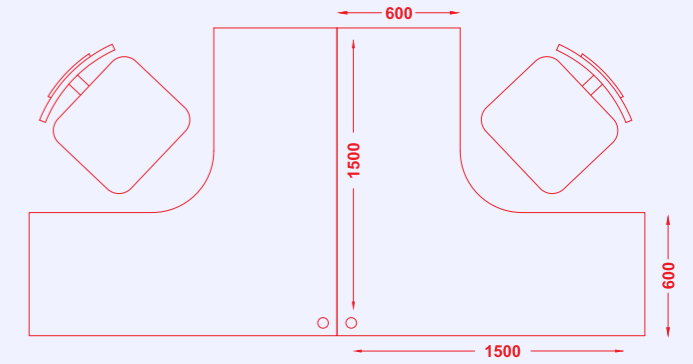
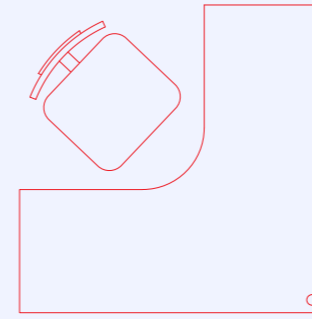

PRODUCT DESCRIPTION

WORKTOP
25MM THICK PL-PB/MDF

LEGS
X50MM / 40X40MM CRCA POWDER COATED

WIRE MANAGEMENT
CRCA POWDER COATED/ PL-PB

PRIVACY SCREENS
MAGNETIC FABRIC / LACQUERED GLASS
/ ACRYLIC / 32MM ALUMINUM PANEL

MODESTY
MS PERFORATED/ PL-PB

* Dimensions in MM

For more information visit us at:
www.amodinisystems.com

CLUSTER
Amodini Workstation

STYLE
Open Desking

CATEGORY
A-OD-06

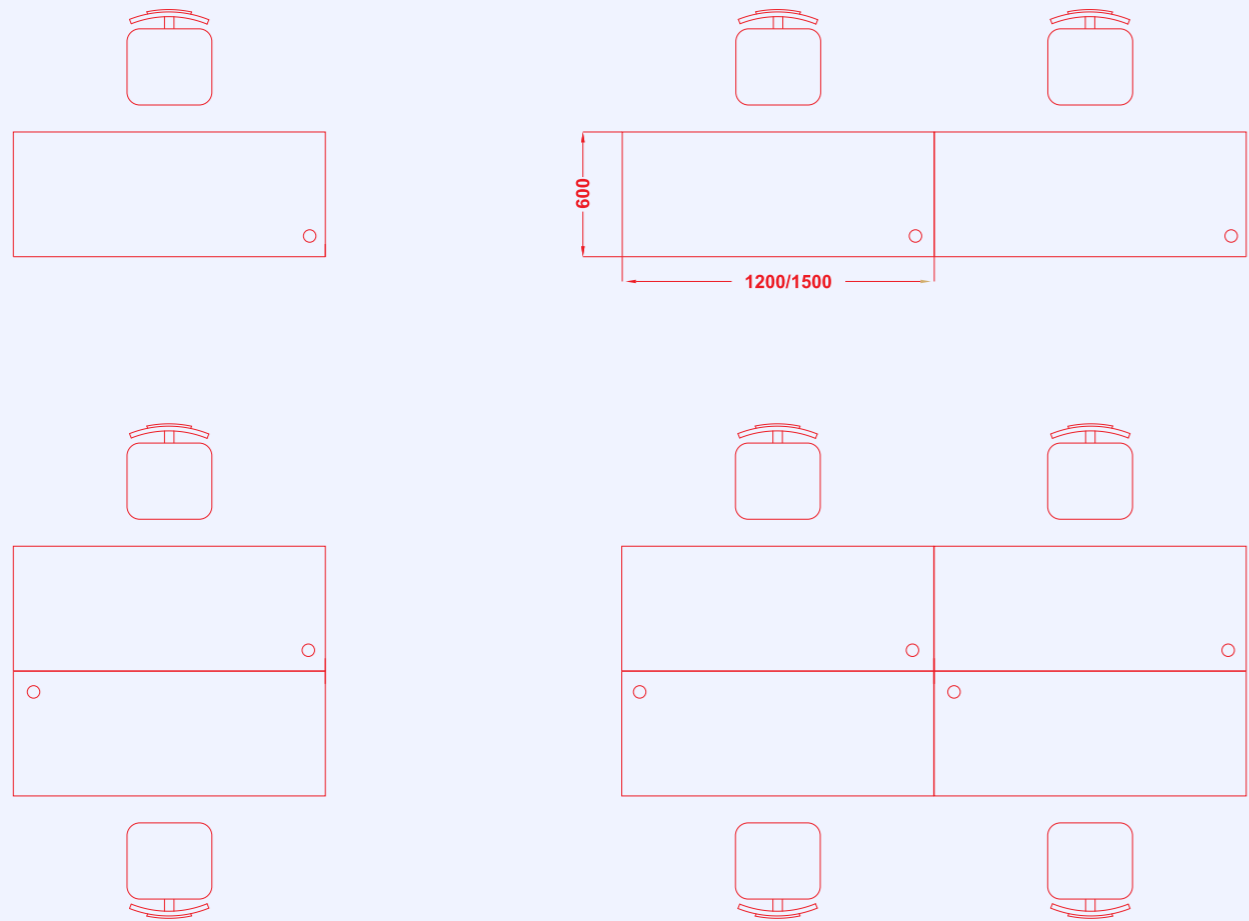

CLUSTER

Amodini Workstation

STYLE

Open Desking

CATEGORY

A-OD-07

* Dimensions in MM

For more information visit us at:
www.amodinisystems.com

PRODUCT DESCRIPTION

WORKTOP

25MM THICK PL-PB/MDF

LEGS

X50MM / 40X40MM CRCA POWDER COATED

WIRE MANAGEMENT

CRCA POWDER COATED/ PL-PB

PRIVACY SCREENS

MAGNETIC FABRIC / LACQUERED GLASS
/ ACRYLIC / 32MM ALUMINUM PANEL

MODESTY

MS PERFORATED/ PL-PB



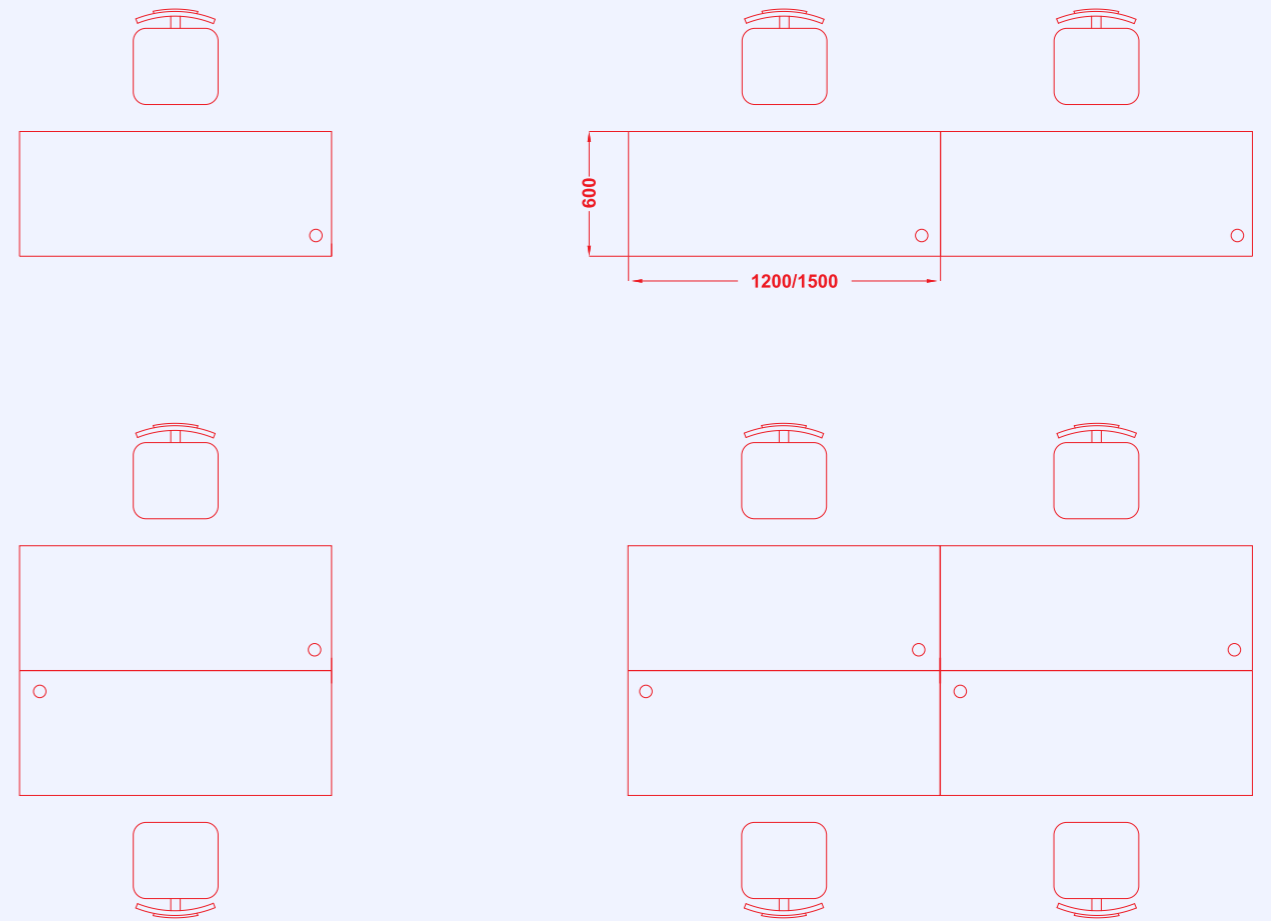

PRODUCT DESCRIPTION

WORKTOP
25MM THICK PL-PB/MDF

LEGS
X50MM / 40X40MM CRCA POWDER COATED

WIRE MANAGEMENT
CRCA POWDER COATED/ PL-PB

PRIVACY SCREENS
MAGNETIC FABRIC / LACQUERED GLASS
/ ACRYLIC / 32MM ALUMINUM PANEL

MODESTY
MS PERFORATED/ PL-PB

* Dimensions in MM

For more information visit us at:
www.amodinisystems.com

CLUSTER
Amodini Workstation

STYLE
Open Desking

CATEGORY
A-OD-08

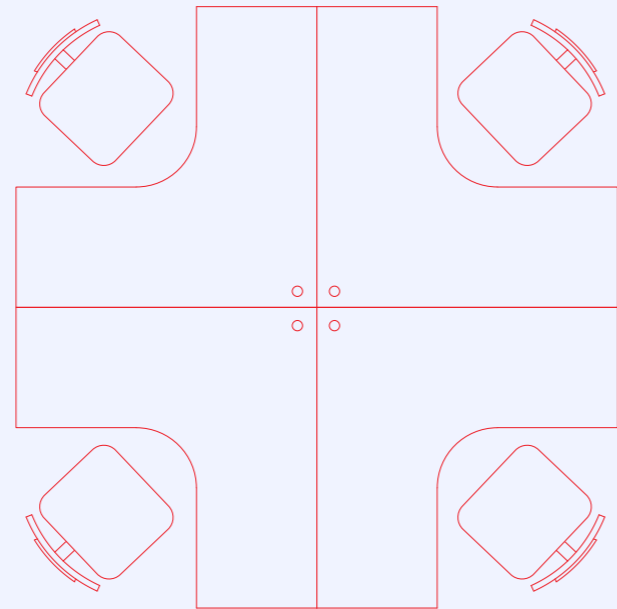
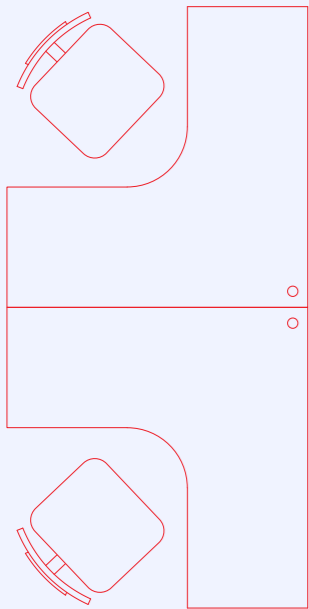
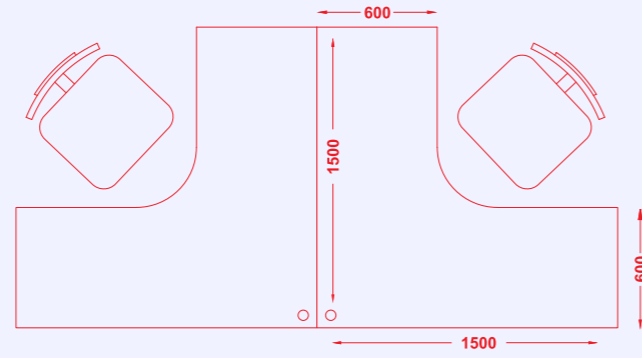
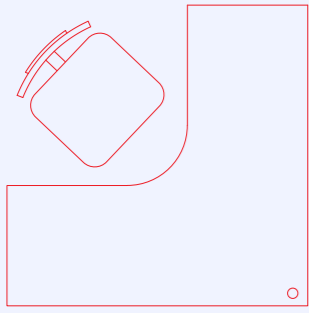

CLUSTER

Amodini Workstation

STYLE

Open Desking

CATEGORY

A-OD-09

* Dimensions in MM

For more information visit us at:
www.amodinisystems.com

PRODUCT DESCRIPTION

WORKTOP
25MM THICK PL-PB/MDF

LEGS
X50MM / 40X40MM CRCA POWDER COATED

WIRE MANAGEMENT
CRCA POWDER COATED/ PL-PB

PRIVACY SCREENS
MAGNETIC FABRIC / LACQUERED GLASS
/ ACRYLIC / 32MM ALUMINUM PANEL

MODESTY
MS PERFORATED/ PL-PB



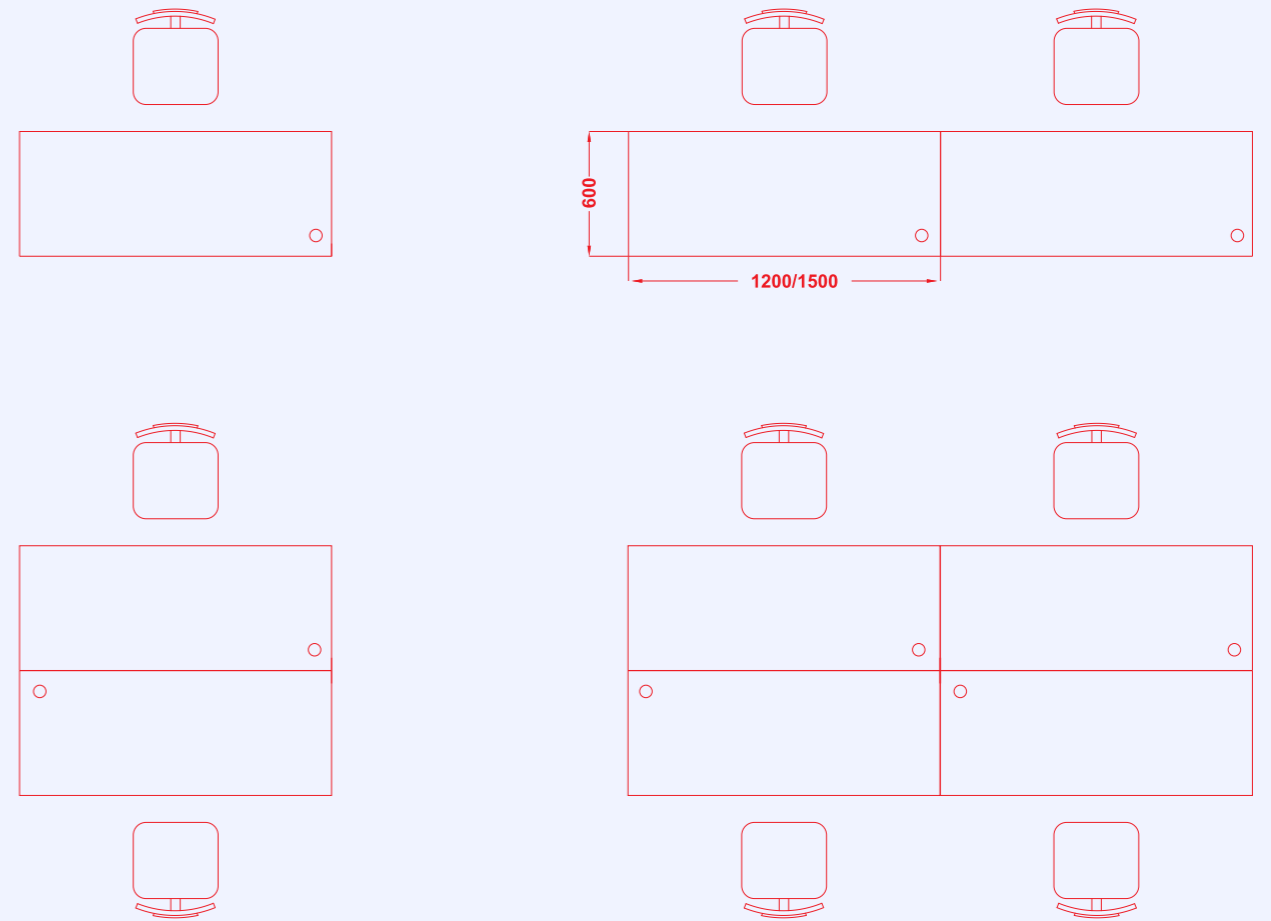

PRODUCT DESCRIPTION

WORKTOP
25MM THICK PL-PB/MDF

LEGS
X50MM / 40X40MM CRCA POWDER COATED

WIRE MANAGEMENT
CRCA POWDER COATED/ PL-PB

PRIVACY SCREENS
MAGNETIC FABRIC / LACQUERED GLASS
/ ACRYLIC / 32MM ALUMINUM PANEL

MODESTY
MS PERFORATED/ PL-PB

* Dimensions in MM

For more information visit us at:
www.amodinisystems.com

CLUSTER
Amodini Workstation

STYLE
Open Desking

CATEGORY
A-OD-10

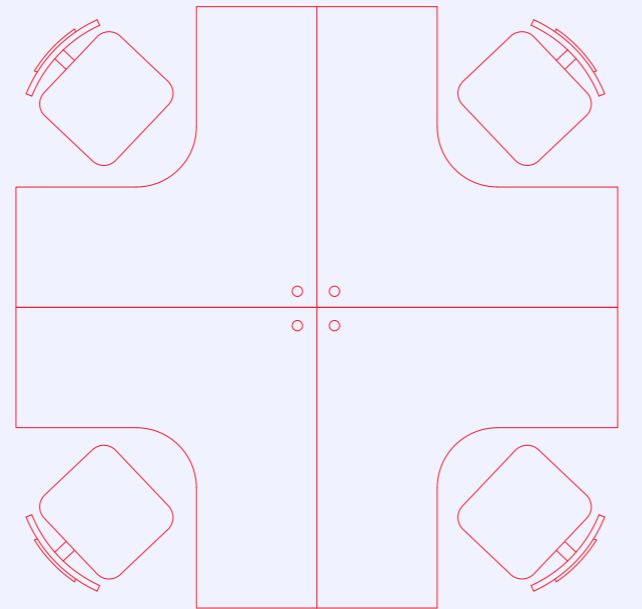
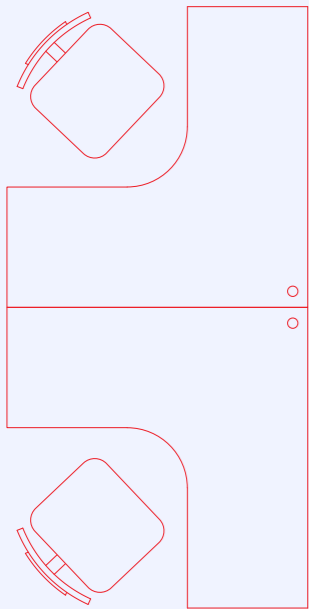
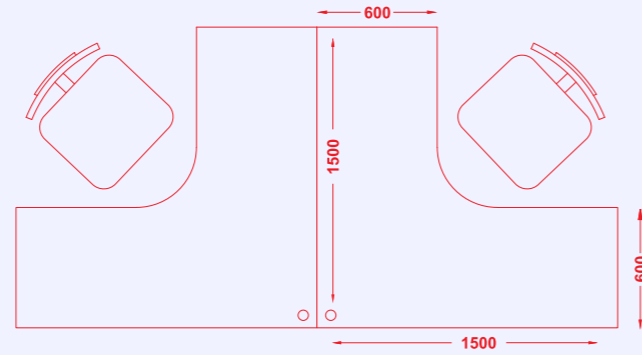
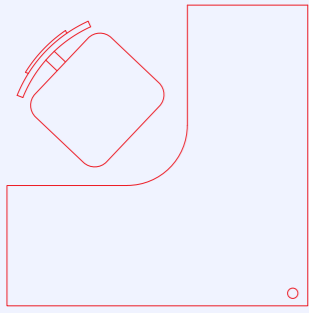

CLUSTER

Amodini Workstation

STYLE

Open Desking

CATEGORY

A-OD-11

* Dimensions in MM

For more information visit us at:
www.amodinisystems.com

PRODUCT DESCRIPTION

WORKTOP

25MM THICK PL-PB/MDF

LEGS

X50MM / 40X40MM CRCA POWDER COATED

WIRE MANAGEMENT

CRCA POWDER COATED/ PL-PB

PRIVACY SCREENS

MAGNETIC FABRIC / LACQUERED GLASS
/ ACRYLIC / 32MM ALUMINUM PANEL

MODESTY

MS PERFORATED/ PL-PB

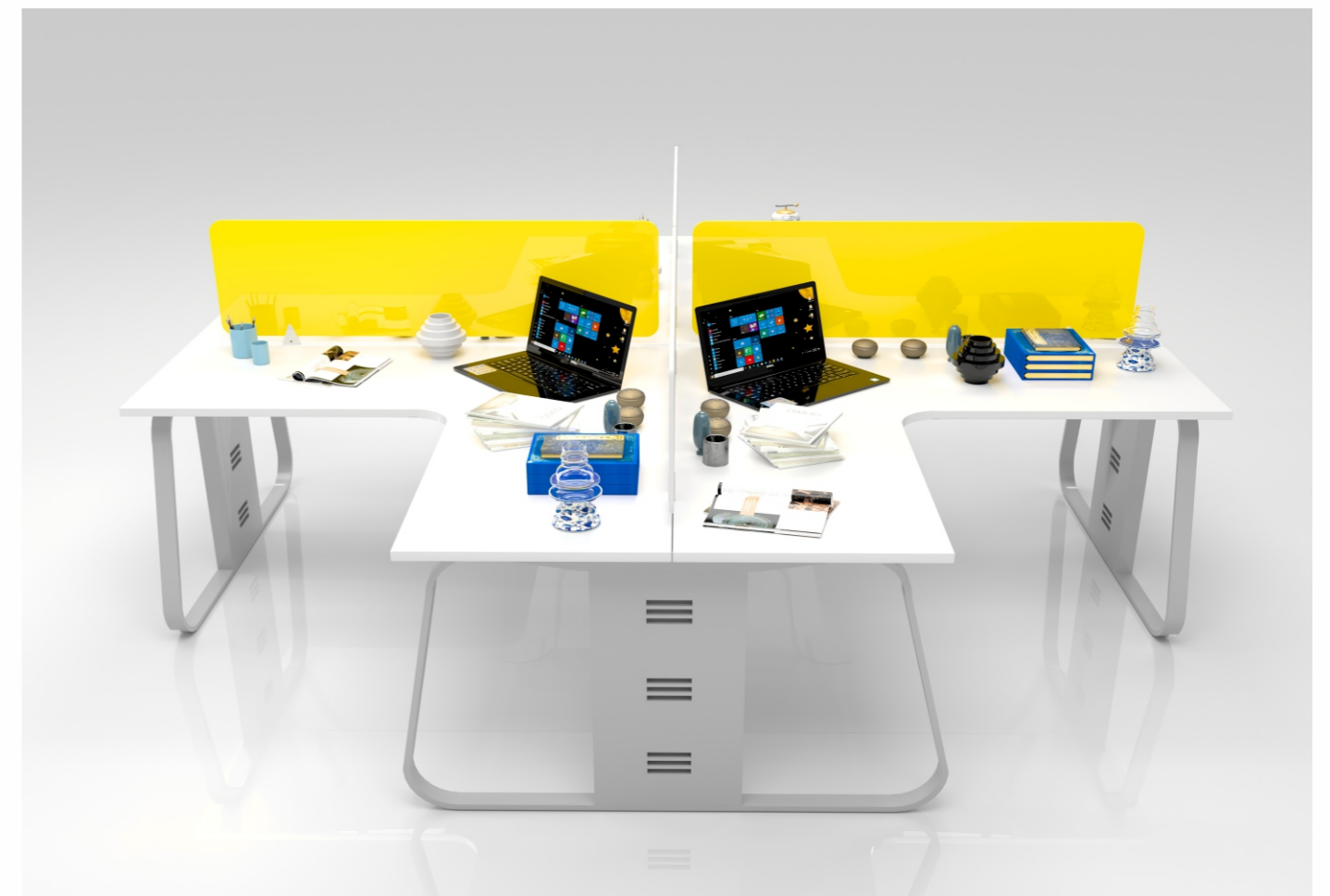

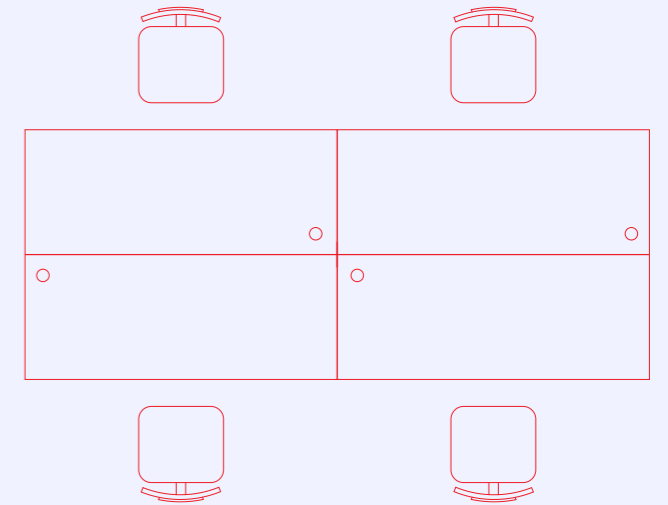
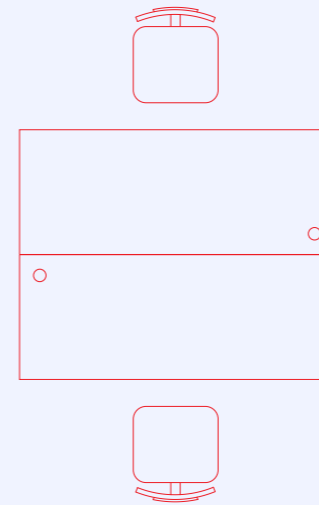
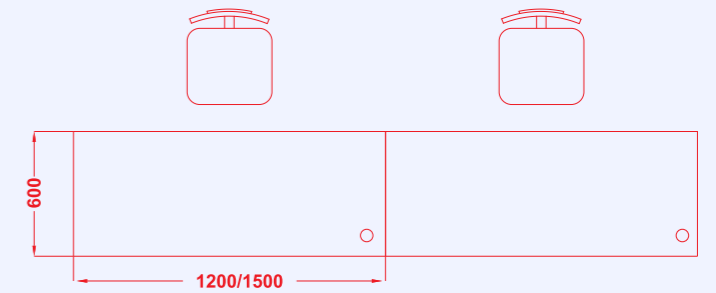
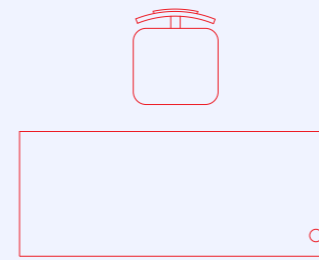

PRODUCT DESCRIPTION

WORKTOP
25MM THICK PL-PB/MDF

LEGS
50X25MM / 60X30 MM CRCA POWDER COATED

WIRE MANAGEMENT
CRCA POWDER COATED/ PL-PB

PRIVACY SCREENS
MAGNETIC FABRIC / LACQUERED GLASS
/ ACRYLIC / 32MM ALUMINUM PANEL

MODESTY
MS PERFORATED/ PL-PB

CLUSTER
Amodini Workstation

STYLE
Open Desking

CATEGORY
A-OD-12

* Dimensions in MM

For more information visit us at:
www.amodinisystems.com

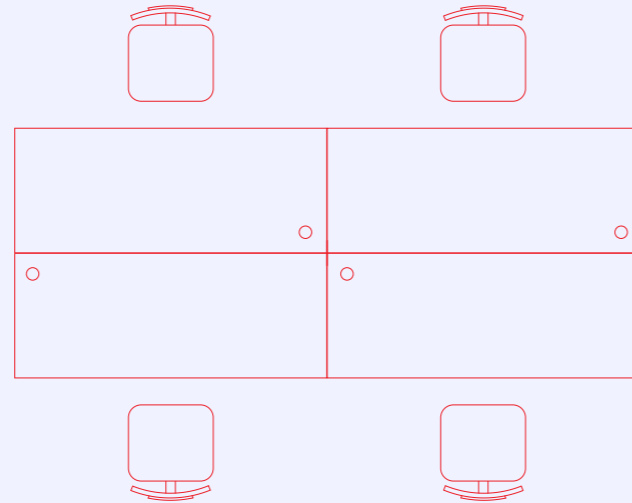
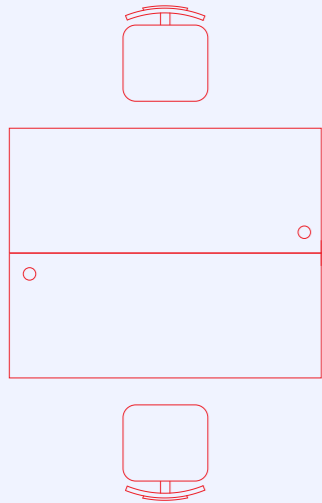
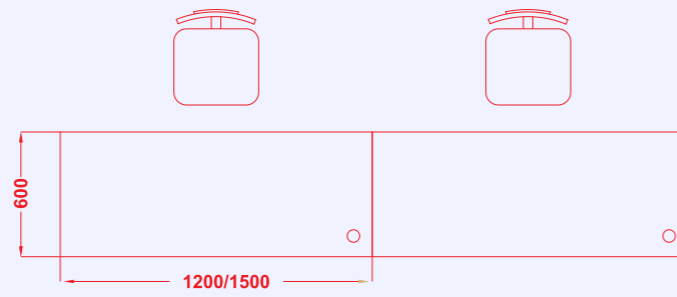
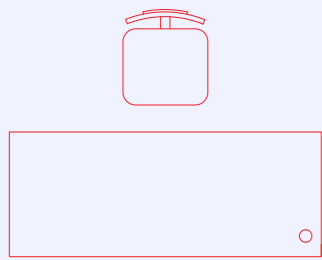

CLUSTER

Amodini Workstation

STYLE

Open Desking

CATEGORY

A-OD-13

* Dimensions in MM

For more information visit us at:
www.amodinisystems.com

PRODUCT DESCRIPTION

WORKTOP
25MM THICK PL-PB/MDF

LEGS
X50MM / 40X40MM CRCA POWDER COATED

WIRE MANAGEMENT
CRCA POWDER COATED/ PL-PB

PRIVACY SCREENS
MAGNETIC FABRIC / LACQUERED GLASS
/ ACRYLIC / 32MM ALUMINUM PANEL

MODESTY
MS PERFORATED/ PL-PB



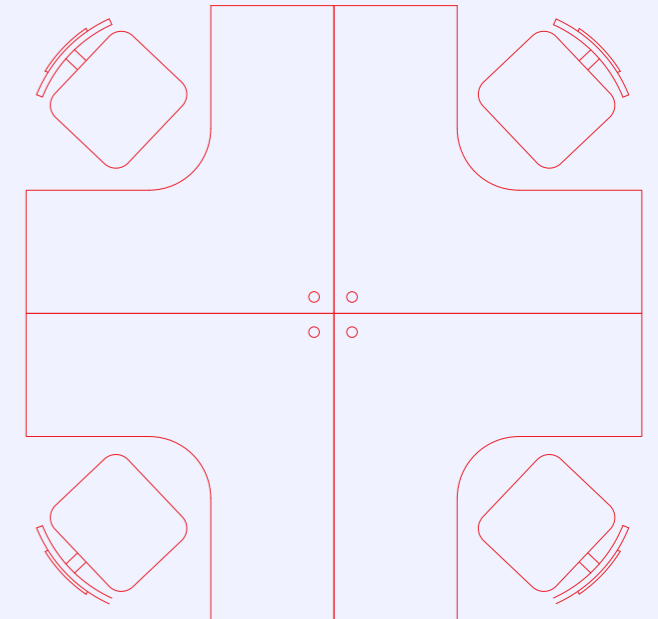
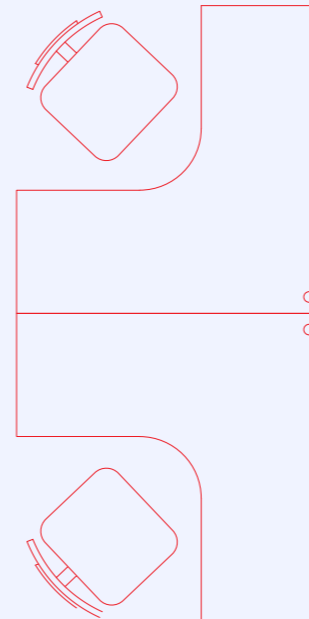
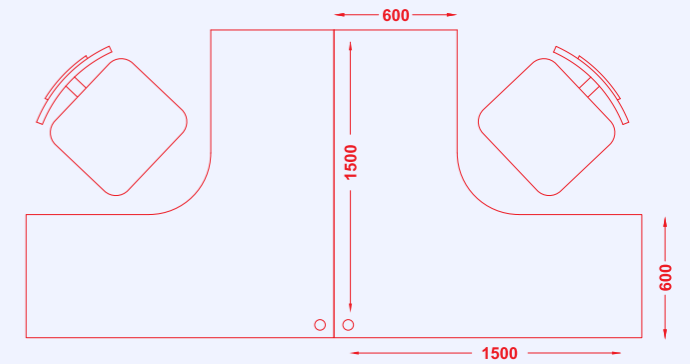
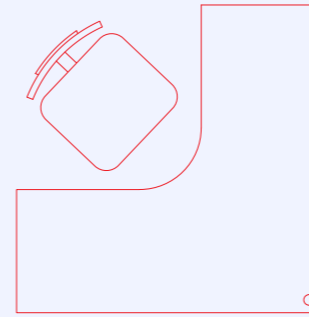

PRODUCT DESCRIPTION

WORKTOP
25MM THICK PL-PB/MDF

LEGS
X50MM / 40X40MM CRCA POWDER COATED

WIRE MANAGEMENT
CRCA POWDER COATED/ PL-PB

PRIVACY SCREENS
MAGNETIC FABRIC / LACQUERED GLASS
/ ACRYLIC / 32MM ALUMINUM PANEL

MODESTY
MS PERFORATED/ PL-PB

CLUSTER
Amodini Workstation

STYLE
Open Desking

CATEGORY
A-OD-14

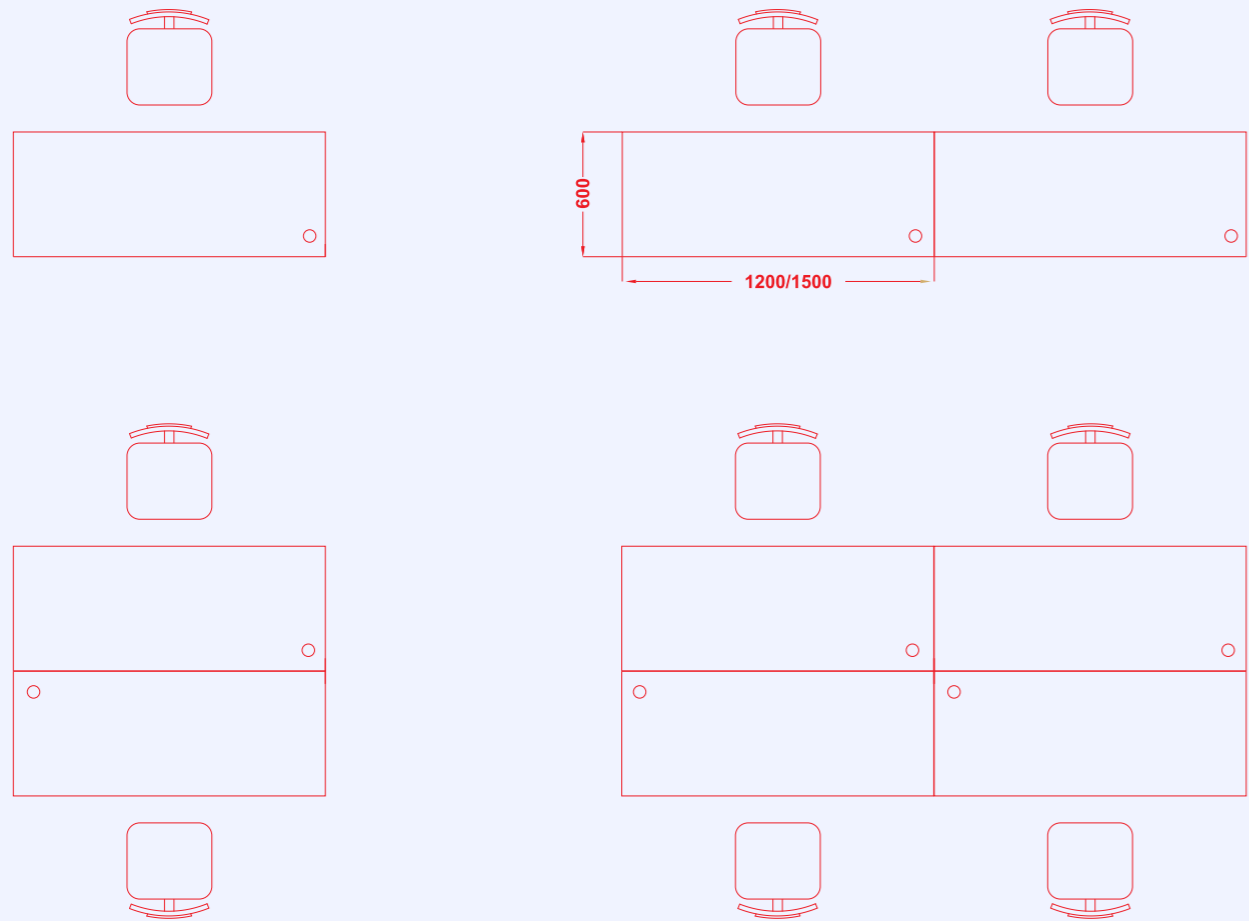

CLUSTER
Amodini Workstation

STYLE
Open Desking

CATEGORY
A-OD-15

* Dimensions in MM
For more information visit us at:
www.amodinisystems.com

PRODUCT DESCRIPTION

- WORKTOP**
25MM THICK PL-PB/MDF
- LEGS**
X50MM / 40X40MM CRCA POWDER COATED
- WIRE MANAGEMENT**
CRCA POWDER COATED/ PL-PB
- PRIVACY SCREENS**
MAGNETIC FABRIC / LACQUERED GLASS / ACRYLIC / 32MM ALUMINUM PANEL
- MODESTY**
MS PERFORATED/ PL-PB



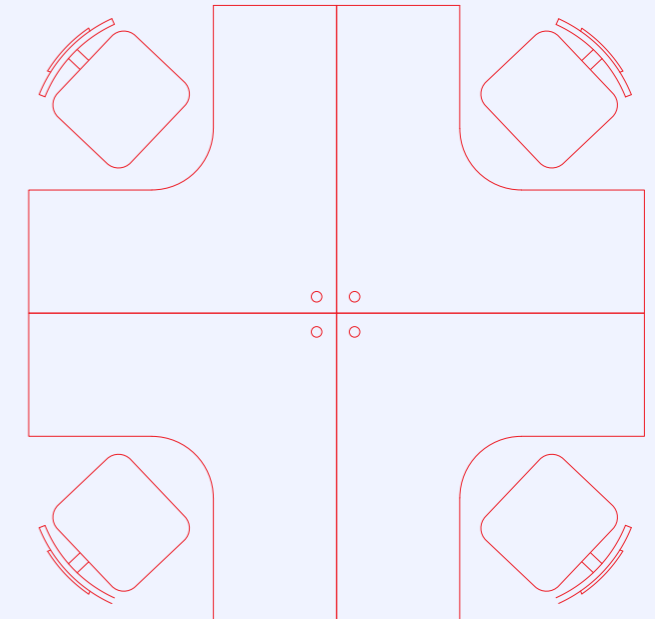
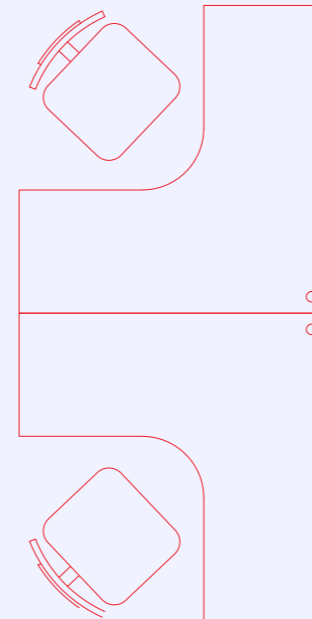
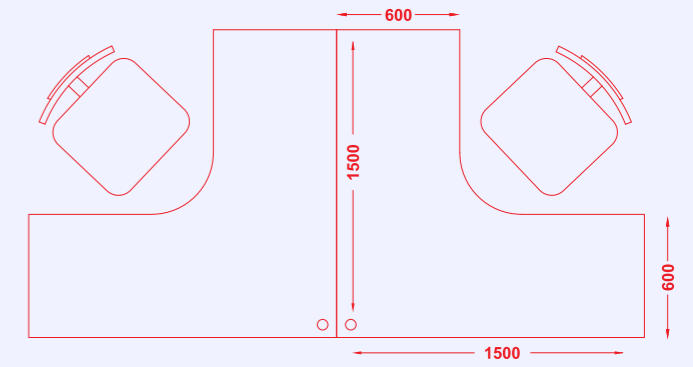
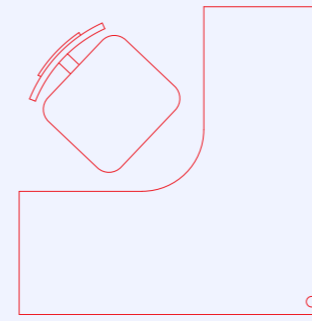

PRODUCT DESCRIPTION

WORKTOP
25MM THICK PL-PB/MDF

LEGS
18/25MM THICK PL-PB/MDF

PARTITION TILE
FABRIC/MARKER/LAMINATE/GLASS

PARTITION THICKNESS
45/60/75MM ALUMINIUM PARTITION

RACEWAY
PROVISION AT SKIRTING LEVEL AND BELOW/ABOVE WORKTOP

CLUSTER
Amodini Workstation

STYLE
Panel Based

CATEGORY
A-PD-01

* Dimensions in MM

For more information visit us at:
www.amodinisystems.com

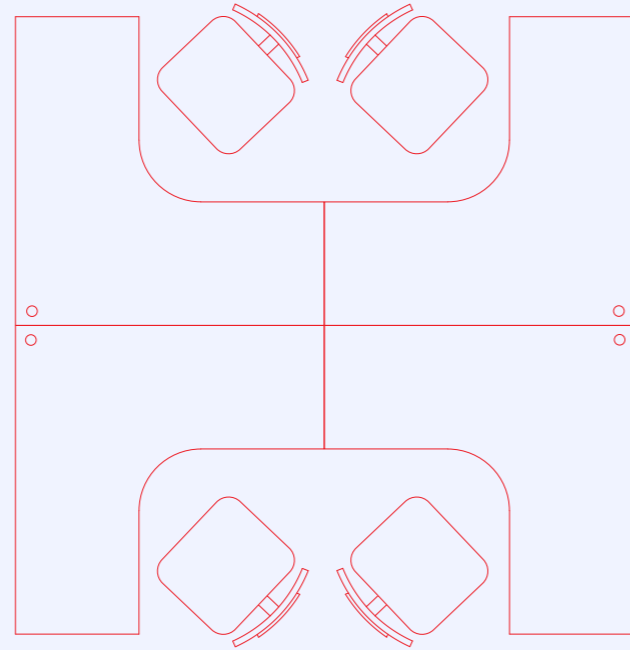
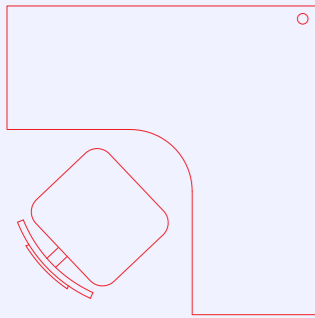
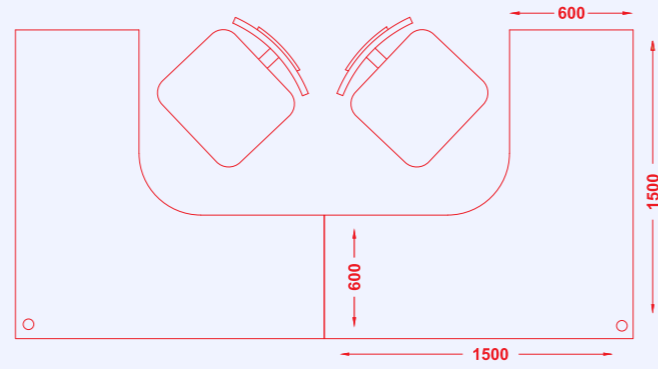
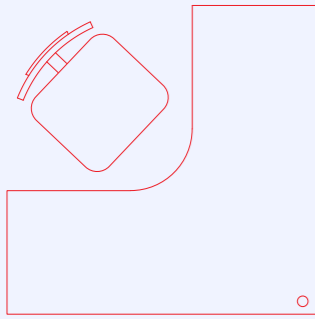

CLUSTER

Amodini Workstation

STYLE

Panel Based

CATEGORY

A-PD-02

* Dimensions in MM

For more information visit us at:
www.amodinisystems.com

PRODUCT DESCRIPTION

WORKTOP

25MM THICK PL-PB/MDF

LEGS

18/25MM THICK PL-PB/MDF

PARTITION TILE

FABRIC/MARKER/LAMINATE/GLASS

PARTITION THICKNESS

45/60/75MM ALUMINIUM PARTITION

RACEWAY

PROVISION AT SKIRTING LEVEL AND BELOW/ABOVE WORKTOP



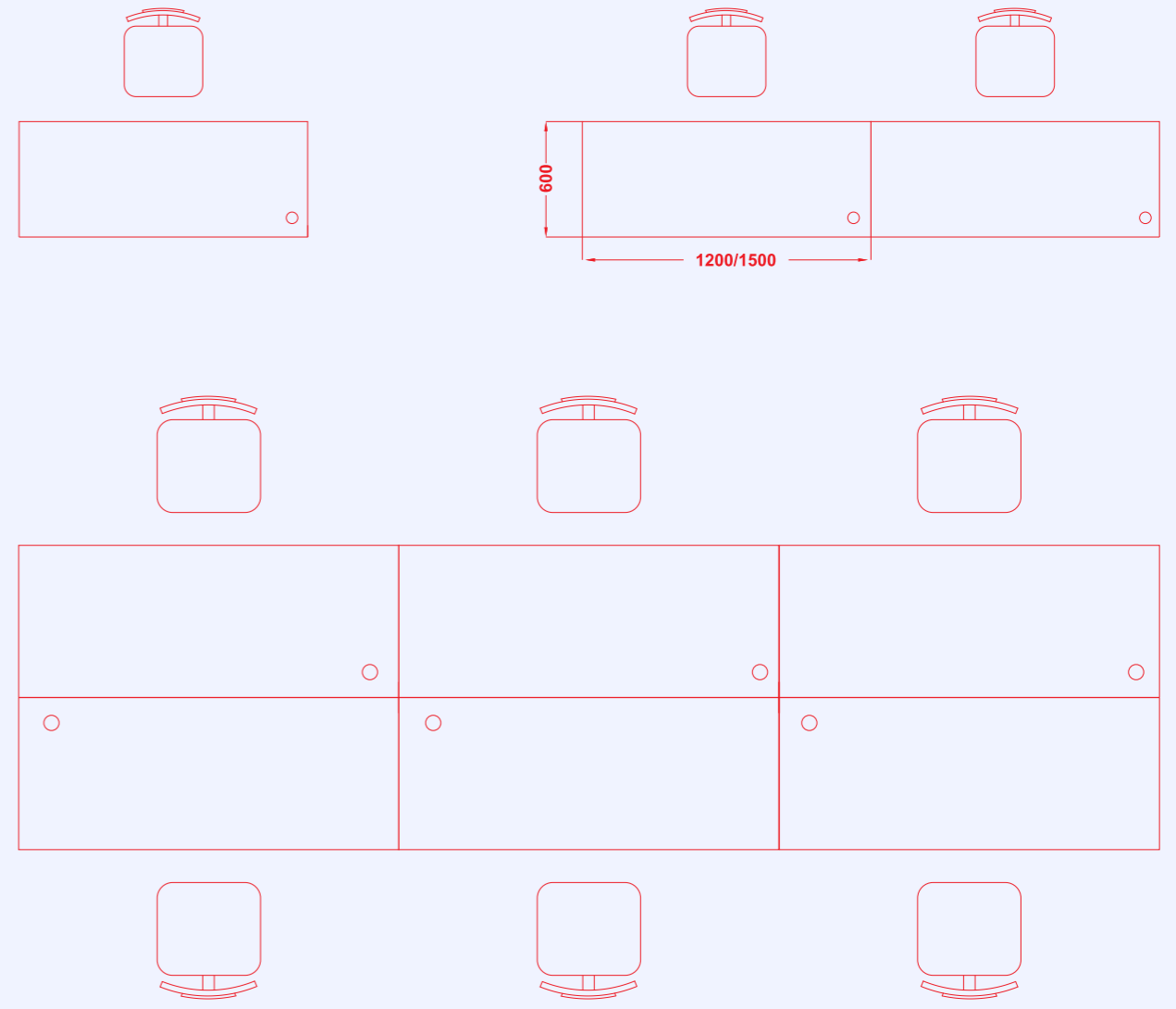

PRODUCT DESCRIPTION

WORKTOP
25MM THICK PL-PB/MDF

LEGS
18/25MM THICK PL-PB/MDF

PARTITION TILE
FABRIC/MARKER/LAMINATE/GLASS

PARTITION THICKNESS
45/60/75MM ALUMINIUM PARTITION

RACEWAY
PROVISION AT SKIRTING LEVEL AND BELOW/ABOVE WORKTOP

CLUSTER
Amodini Workstation

STYLE
Panel Based

CATEGORY
A-PD-03

* Dimensions in MM

For more information visit us at:
www.amodinisystems.com

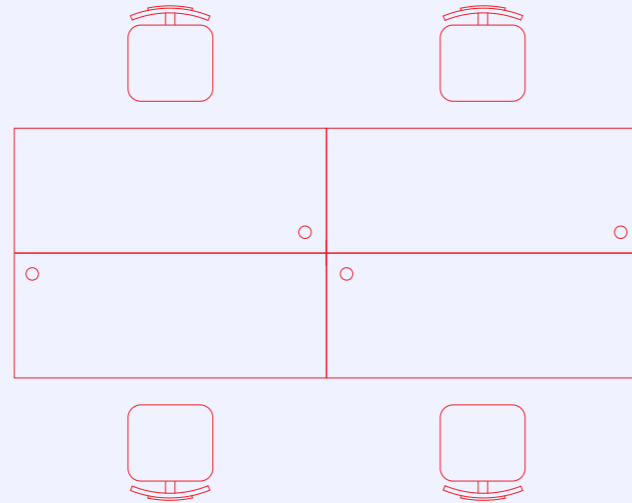
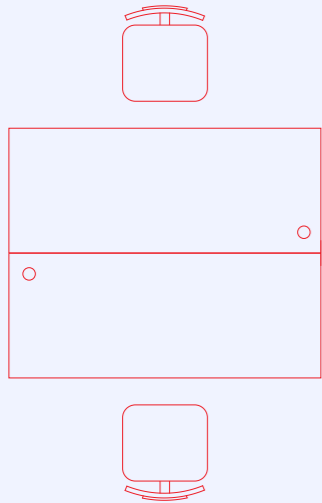
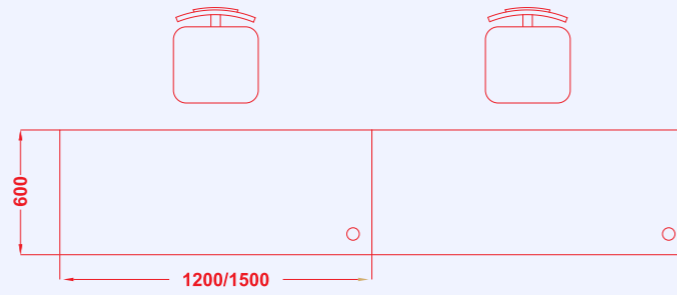
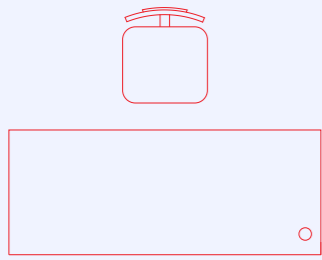

CLUSTER

Amodini Workstation

STYLE

Panel Based

CATEGORY

A-PD-03

* Dimensions in MM

For more information visit us at:
www.amodinisystems.com

PRODUCT DESCRIPTION

WORKTOP

25MM THICK PL-PB/MDF

LEGS

18/25MM THICK PL-PB/MDF

PARTITION TILE

FABRIC/MARKER/LAMINATE/GLASS

PARTITION THICKNESS

45/60/75MM ALUMINIUM PARTITION

RACEWAY

PROVISION AT SKIRTING LEVEL AND BELOW/ABOVE WORKTOP



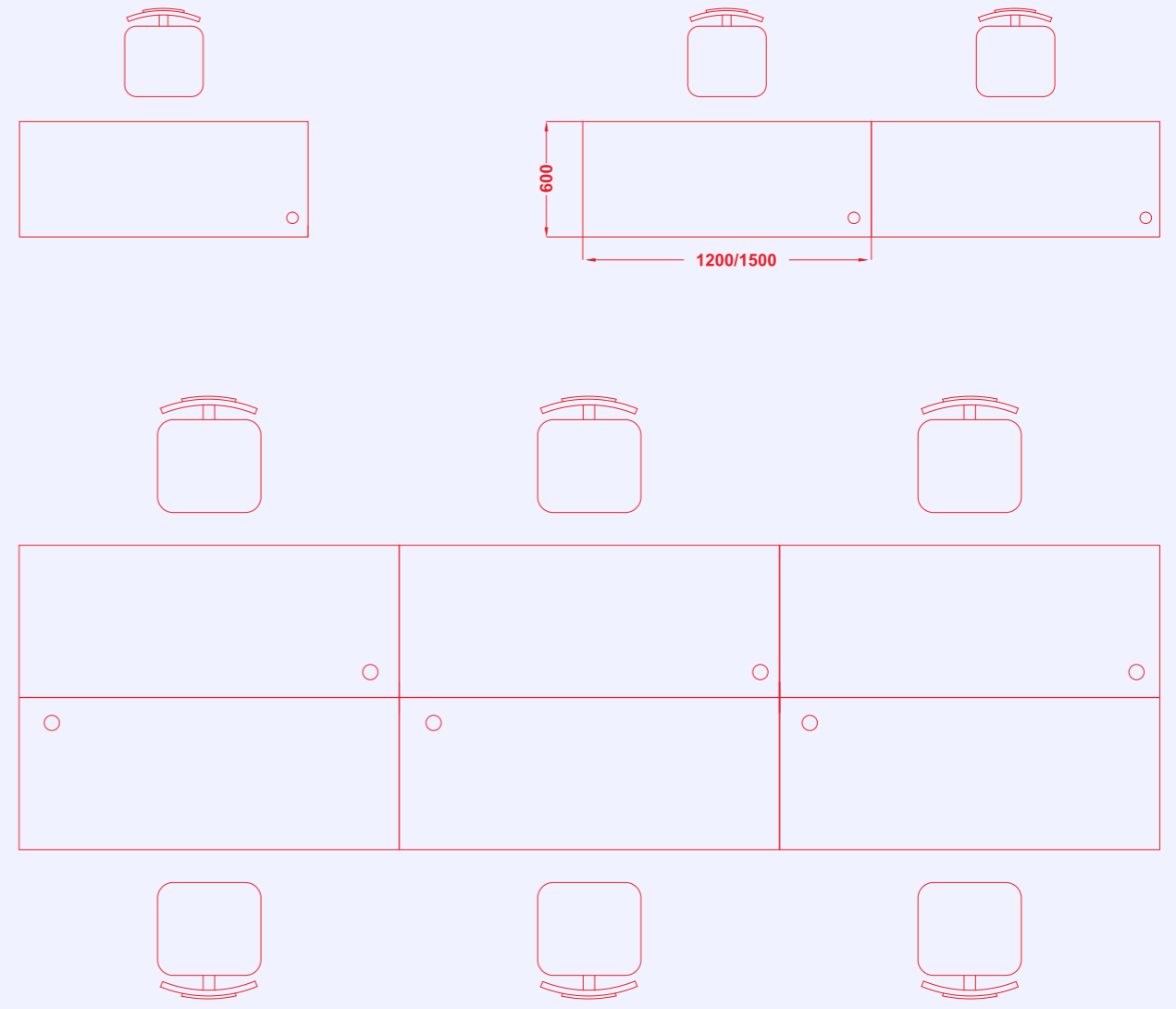

PRODUCT DESCRIPTION

WORKTOP
25MM THICK PL-PB/MDF

LEGS
18/25MM THICK PL-PB/MDF

PARTITION TILE
FABRIC/MARKER/LAMINATE/GLASS

PARTITION THICKNESS
45/60/75MM ALUMINIUM PARTITION

RACEWAY
PROVISION AT SKIRTING LEVEL AND BELOW/ABOVE WORKTOP

CLUSTER
Amodini Workstation

STYLE
Panel Based

CATEGORY
A-PD-05

* Dimensions in MM

For more information visit us at:
www.amodinisystems.com

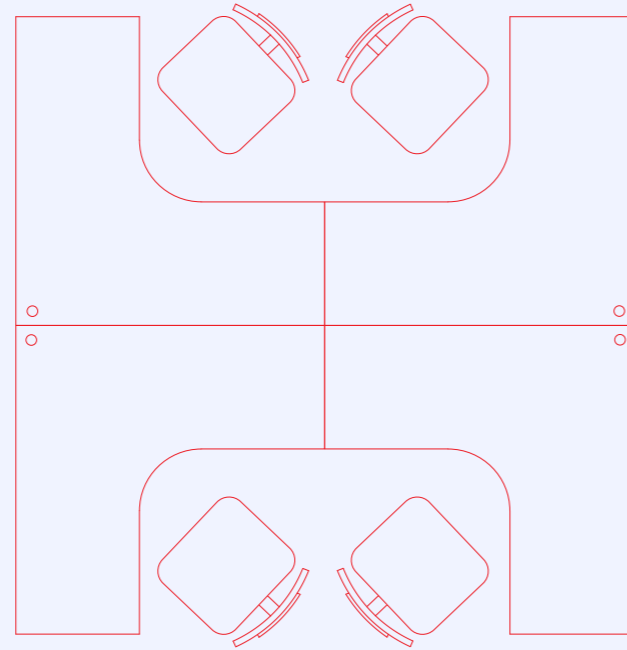
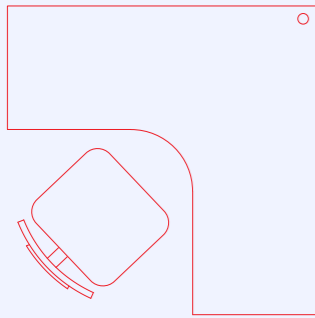
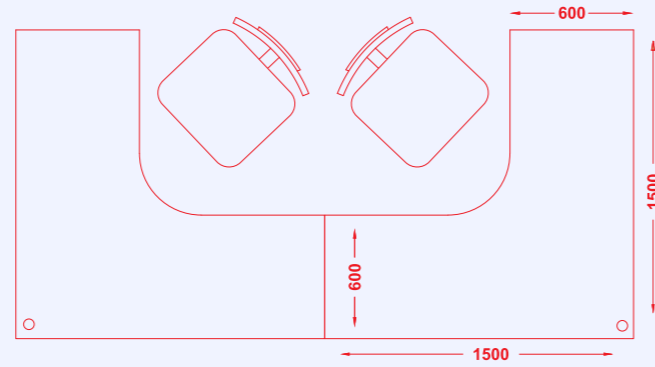
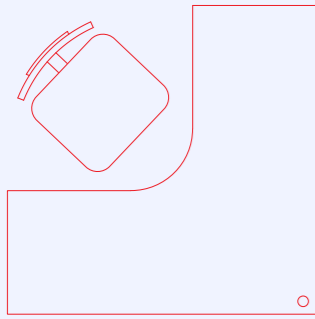

CLUSTER

Amodini Workstation

STYLE

Panel Based

CATEGORY

A-PD-06

* Dimensions in MM

For more information visit us at:
www.amodinisystems.com

PRODUCT DESCRIPTION

WORKTOP

25MM THICK PL-PB/MDF

LEGS

18/25MM THICK PL-PB/MDF

PARTITION TILE

FABRIC/MARKER/LAMINATE/GLASS

PARTITION THICKNESS

45/60/75MM ALUMINIUM PARTITION

RACEWAY

PROVISION AT SKIRTING LEVEL AND
BELOW/ABOVE WORKTOP



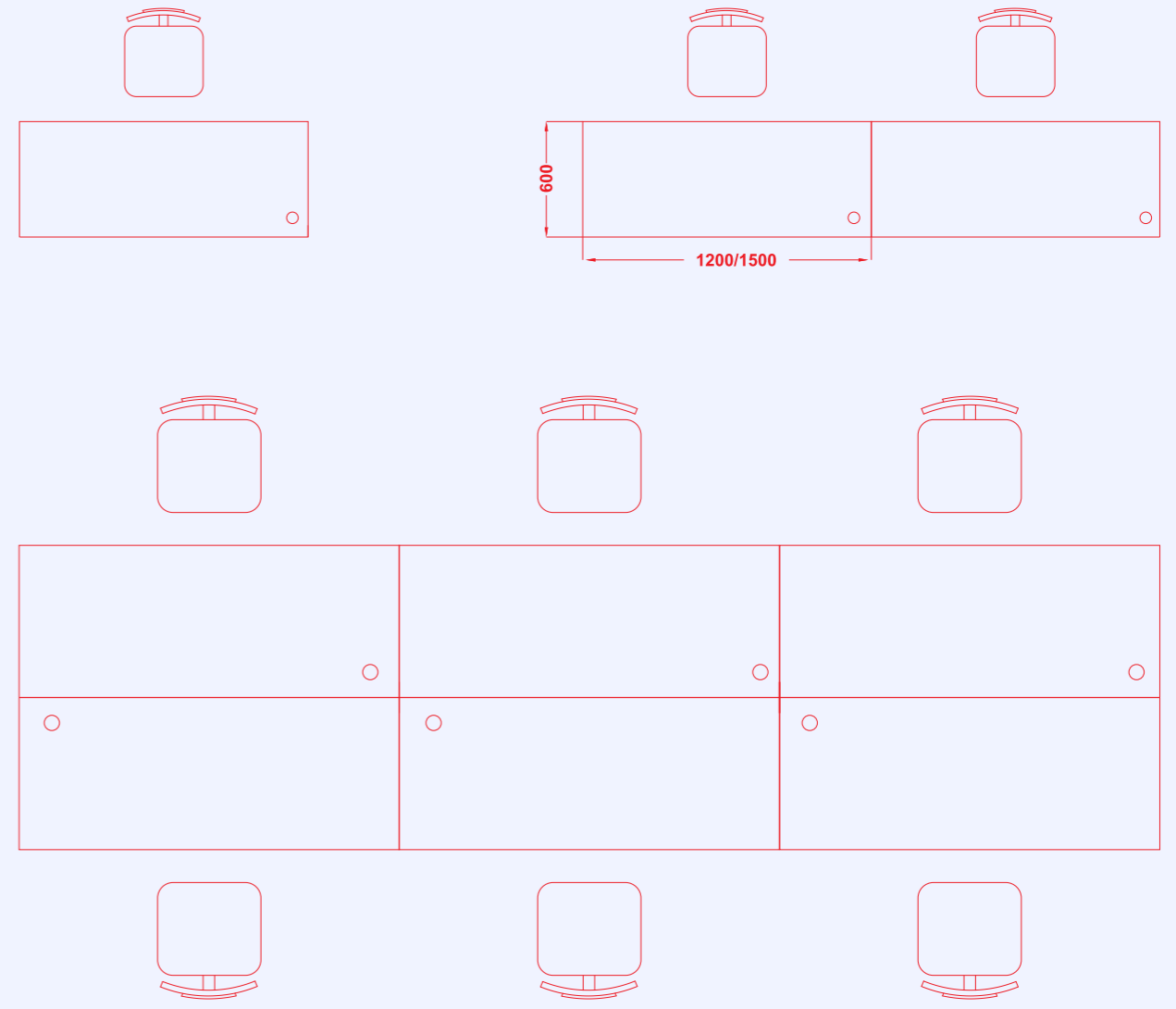

PRODUCT DESCRIPTION

WORKTOP
25MM THICK PL-PB/MDF

LEGS
18/25MM THICK PL-PB/MDF

PARTITION TILE
FABRIC/MARKER/LAMINATE/GLASS

PARTITION THICKNESS
45/60/75MM ALUMINIUM PARTITION

RACEWAY
PROVISION AT SKIRTING LEVEL AND BELOW/ABOVE WORKTOP

CLUSTER
Amodini Workstation

STYLE
Panel Based

CATEGORY
A-PD-07

* Dimensions in MM

For more information visit us at:
www.amodinisystems.com



Executive Table

We have emerged as a top-notch manufacture and supplier of high quality desking system of all types. Our stock is rich with some exclusive desking systems designed for corporate offices and MNCs.

We provide this desking system in partitions that allow multiple executives to install their systems and work on same workstation together.

The table possesses a modern design and a right shape along with coloured partition. We ensure for high level quality, durability and perfect finish in all types of desking systems designed by us.

We develop and design for the same quality desking system for office use as per our

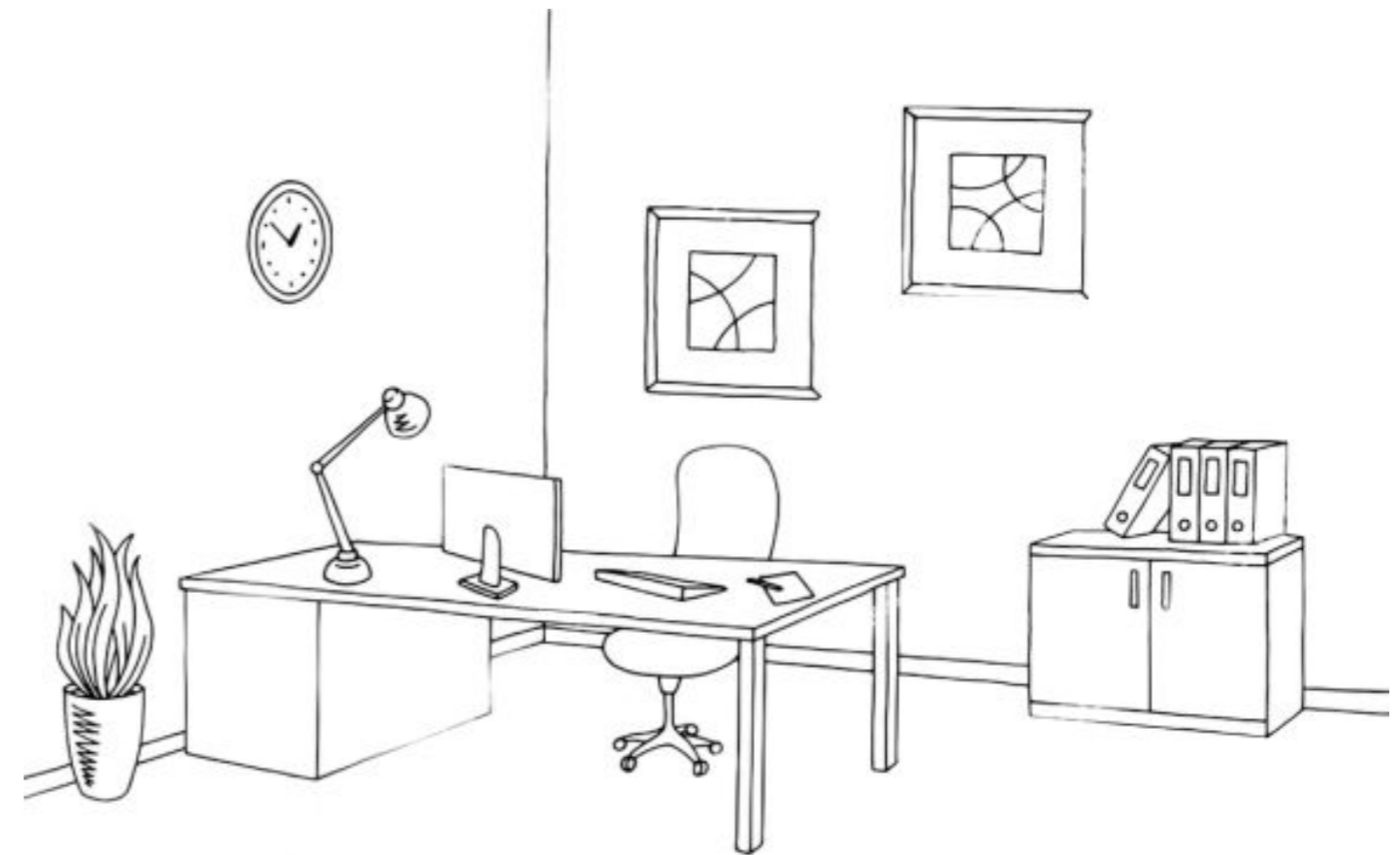



L.H.S

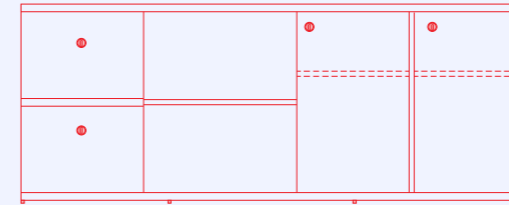

R.H.S

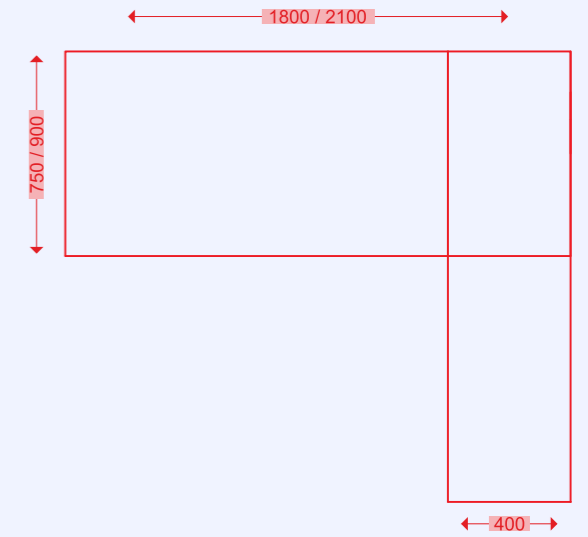
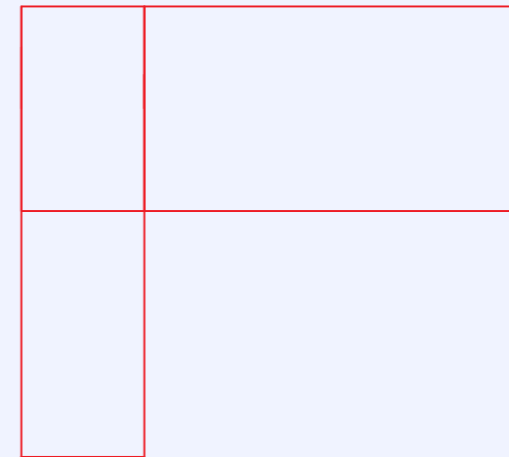
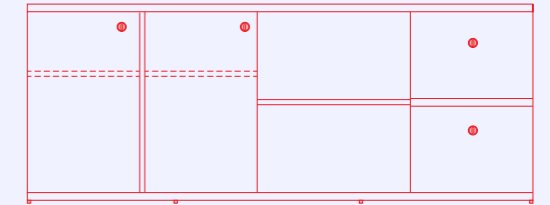

PRODUCT DESCRIPTION

WORKTOP
25MM THICK PL-PB/MDF

LEGS
60MM X 30MM CRCA POWDER COATED

MODESTY
18MM THICK PL-PB/MDF

SIDE CREDENZA
18MM THICK PL-PB/MDF

Product
Amodini Table

STYLE
Cabin Desk

CATEGORY
A-CD-01

* Dimensions in MM

For more information visit us at:
www.amodinisystems.com

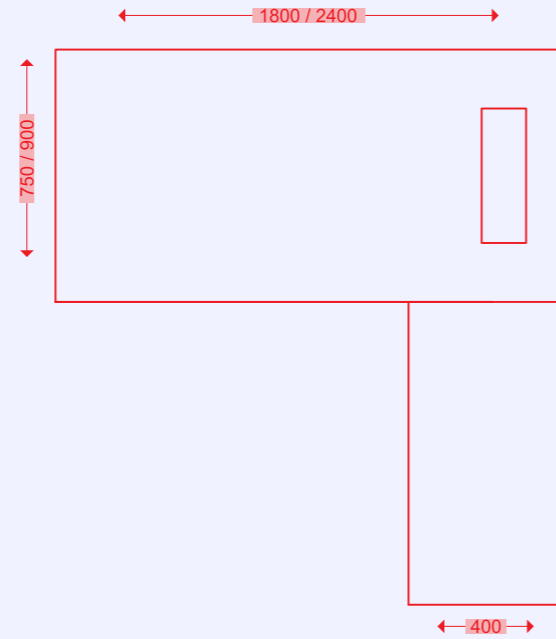
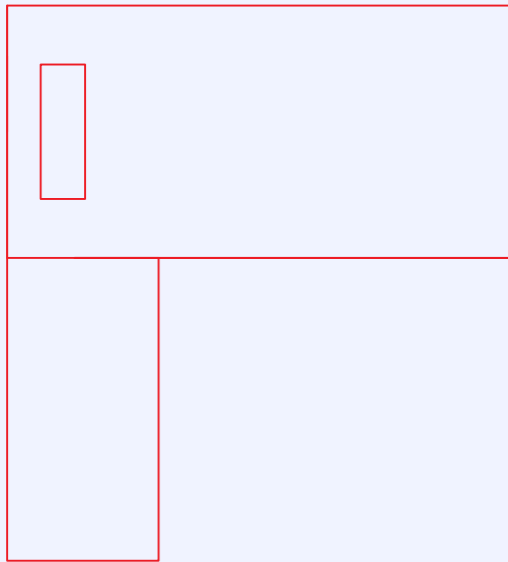
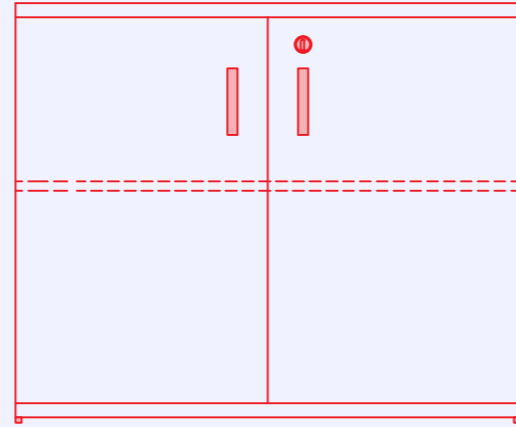
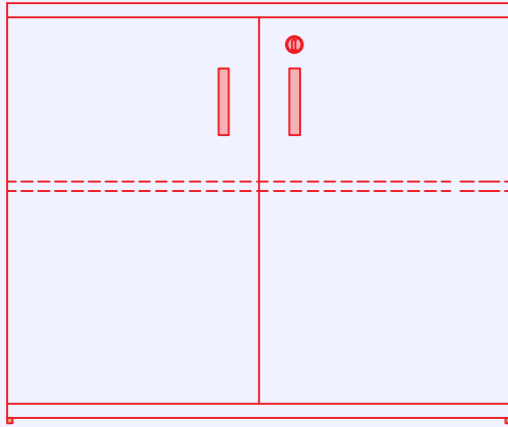

Product

Amodini Table

STYLE

Cabin Desk

PRODUCT DESCRIPTION

WORKTOP
42MM THICK PL-PB/MDF

LEGS
36MM THICK PL-PB/MDF

MODESTY
18MM THICK PL-PB/MDF

SIDE CREDENZA
18MM THICK PL-PB/MDF

WIRE MANAGEMENT
ALUMINIUM FLAP WITH
MS CABLE CARRIER AND RISER

* Dimensions in MM

For more information visit us at:
www.amodinisystems.com



L.H.S

R.H.S

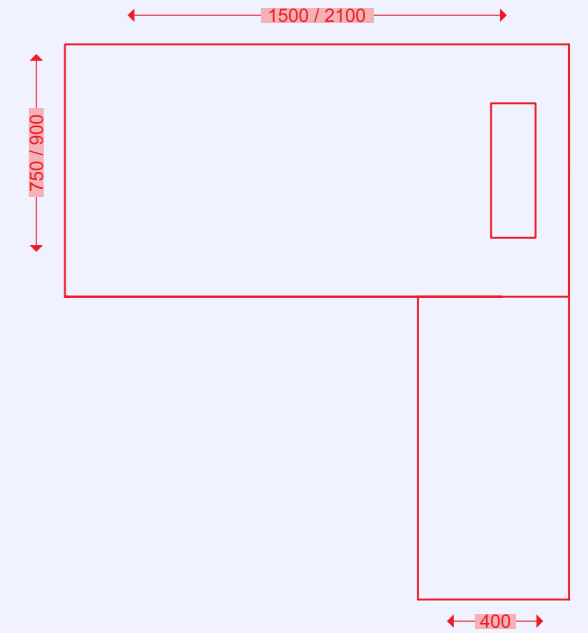
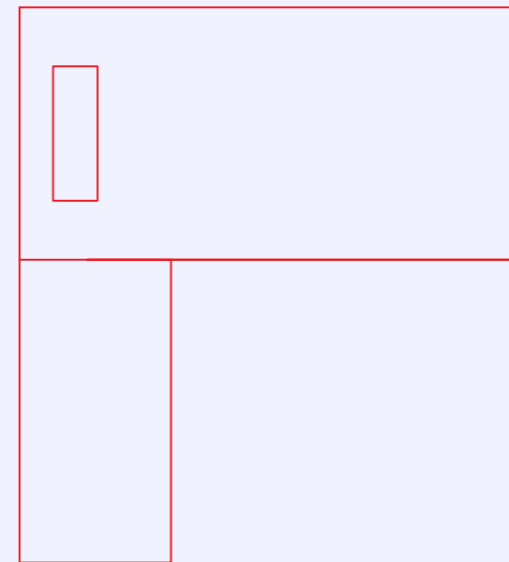
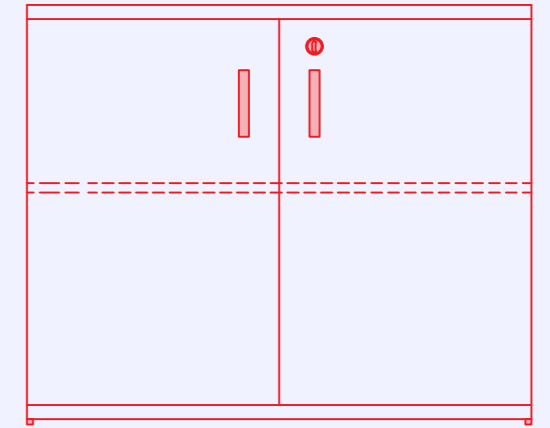
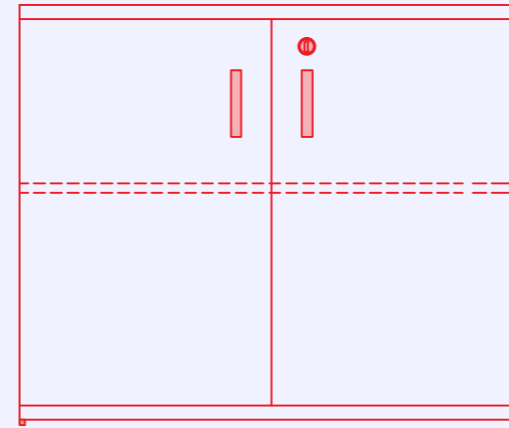

PRODUCT DESCRIPTION

WORKTOP
25MM THICK PL-PB/MDF

LEGS
60MM X 30MM CRCA POWDER COATED

MODESTY
18MM THICK PL-PB/MDF

SIDE CREDENZA
18MM THICK PL-PB/MDF

Product
Amodini Table

STYLE
Cabin Desk

CATEGORY
A-CD-03

* Dimensions in MM

For more information visit us at:
www.amodinisystems.com

L.H.S

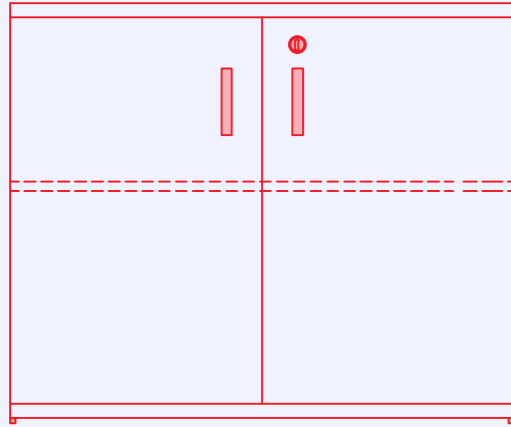

R.H.S

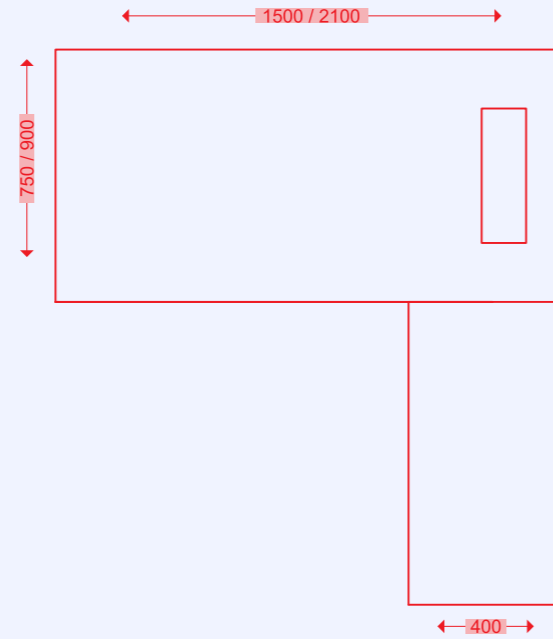
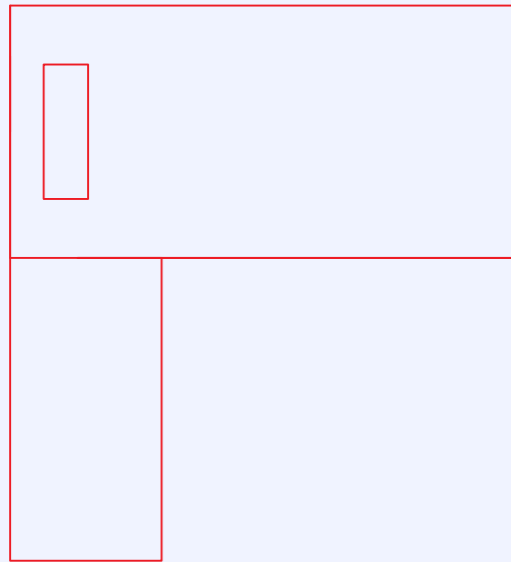
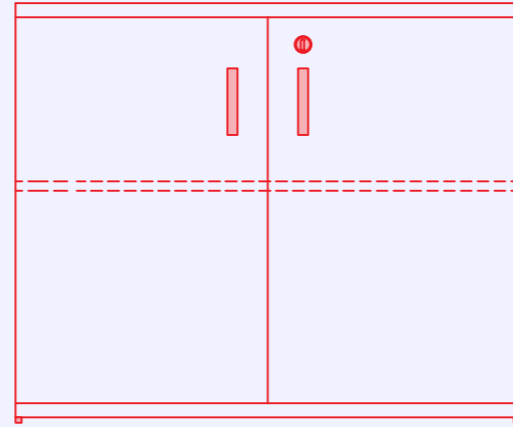

Product

Amodini Table

STYLE

Cabin Desk

CATEGORY

A-CD-04

PRODUCT DESCRIPTION

WORKTOP
42MM THICK PL-PB/MDF

LEGS
36MM THICK PL-PB/MDF

MODESTY
18MM THICK PL-PB/MDF

SIDE CREDENZA
18MM THICK PL-PB/MDF

WIRE MANAGEMENT
ALUMINIUM FLAP WITH
MS CABLE CARRIER AND RISER

* Dimensions in MM

For more information visit us at:
www.amodinisystems.com



L.H.S

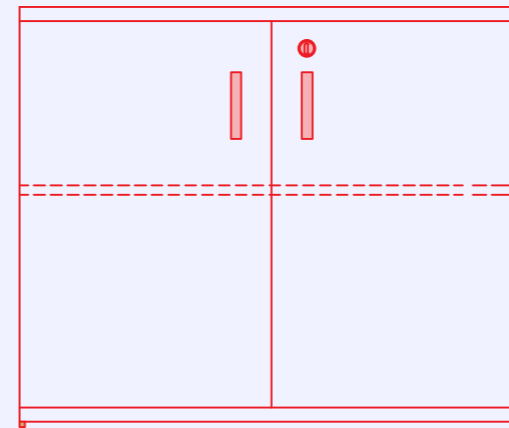

R.H.S

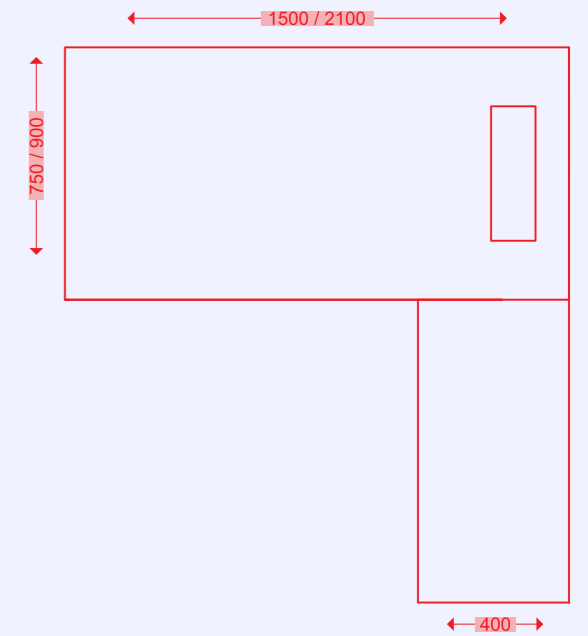
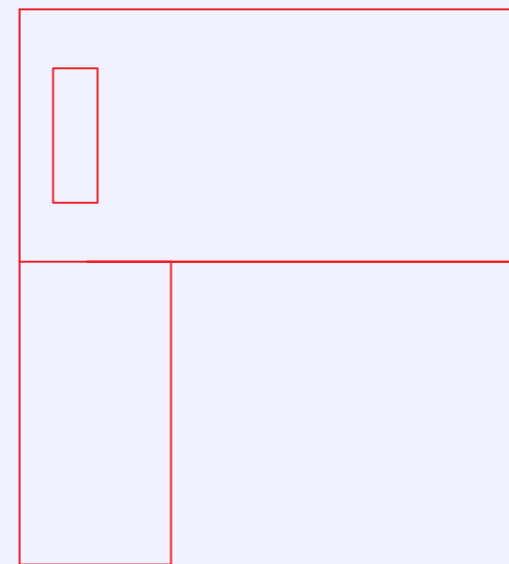
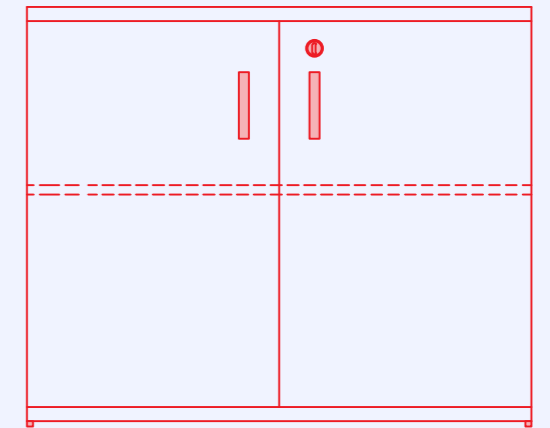

PRODUCT DESCRIPTION

WORKTOP
25MM THICK PL-PB/MDF

LEGS
60MM X 30MM CRCA POWDER COATED

MODESTY
18MM THICK PL-PB/MDF

SIDE CREDENZA
18MM THICK PL-PB/MDF

Product
Amodini Table

STYLE
Cabin Desk

CATEGORY
A-CD-05

* Dimensions in MM

For more information visit us at:
www.amodinisystems.com

L.H.S

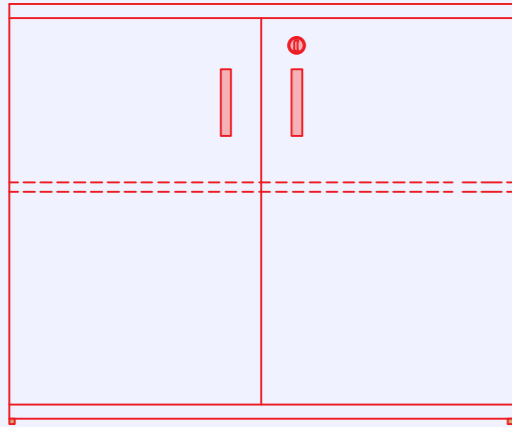

R.H.S

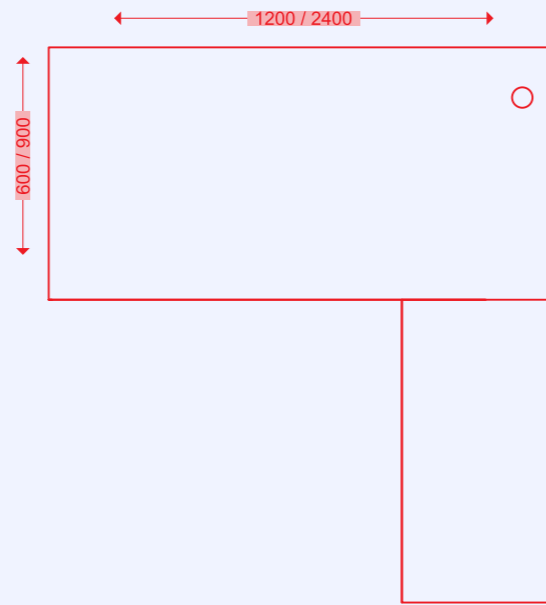
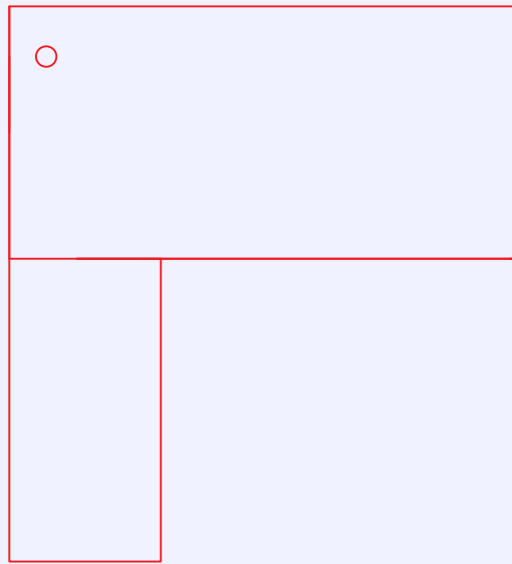
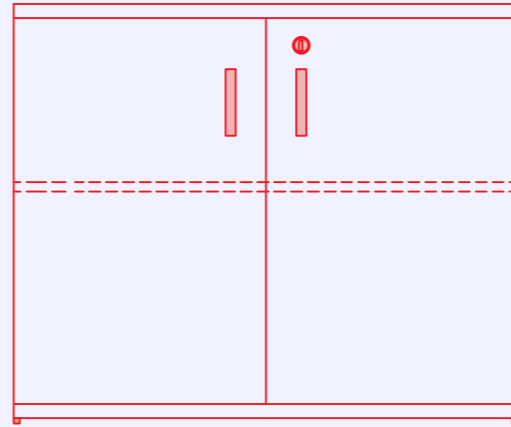

* Dimensions in MM

Product

Amodini Table

STYLE

Cabin Desk

CATEGORY

A-CD-06

* Dimensions in MM

For more information visit us at:
www.amodinisystems.com

PRODUCT DESCRIPTION

WORKTOP
42MM THICK PL-PB/MDF

LEGS
36MM THICK PL-PB/MDF

MODESTY
18MM THICK PL-PB/MDF

SIDE CREDENZA
18MM THICK PL-PB/MDF

WIRE MANAGEMENT
ALUMINIUM FLAP WITH
MS CABLE CARRIER AND RISER





Meeting / Conference Tables

We specialize in manufacturing and supplying the optimum quality executive tables possessing innovative designs, good finish and immense durability as well. We use quality wood, steel and laminate materials for developing highly finished tables for executives work in corporate offices, call centres, and multinational companies. We develop executive tables in diverse shapes rectangle, round, partition etc., along with multiple racks or drawers in them. All our tables are strong and have a long term stability. Also, we are able to develop customized executive tables as per the customer's choice.



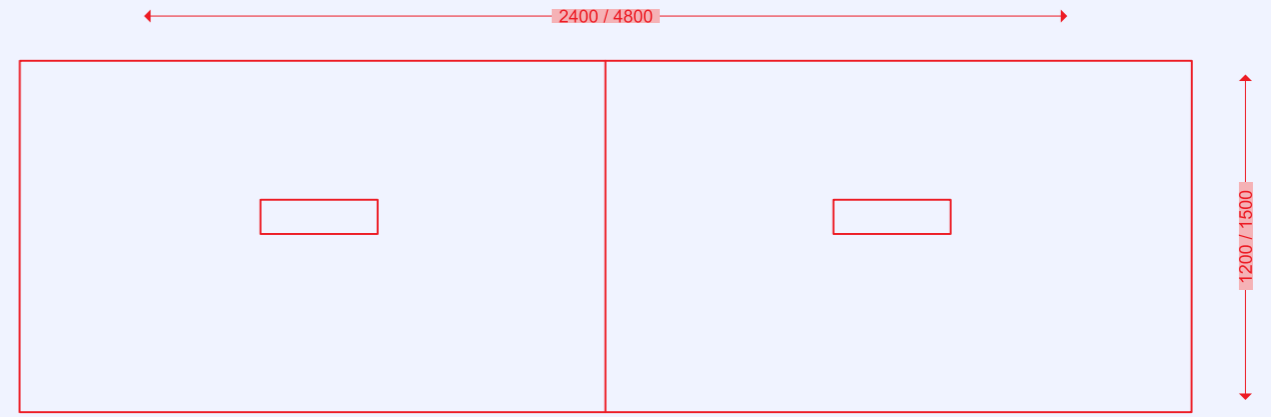

PRODUCT DESCRIPTION

WORKTOP
25MM THICK PL-PB/MDF

LEGS
25MM THICK PL-PB/MDF

MODESTY
18MM THICK PL-PB/MDF

WIRE MANAGEMENT
ALUMINIUM FLAP WITH
MS CABLE CARRIER AND RISER

CLUSTER
Amodini Workstation

STYLE
Meeting/ Conference Table

CATEGORY
A-CT-01

* Dimensions in MM

For more information visit us at:
www.amodinisystems.com

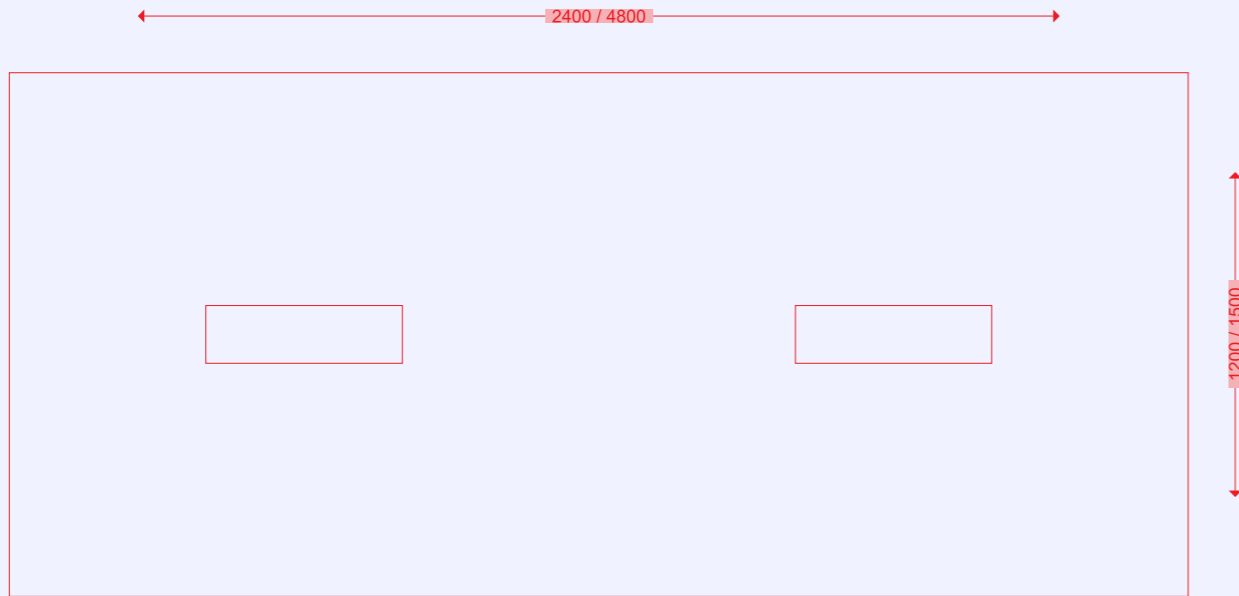

CLUSTER

Amodini Workstation

STYLE

Meeting/ Conference Table

CATEGORY

A-CT-02

PRODUCT DESCRIPTION

WORKTOP

25MM THICK PL-PB/MDF

LEGS

25MM THICK PL-PB/MDF

MODESTY

18MM THICK PL-PB/MDF

WIRE MANAGEMENT

ALUMINIUM FLAP WITH
MS CABLE CARRIER AND RISER

* Dimensions in MM

For more information visit us at:
www.amodinisystems.com



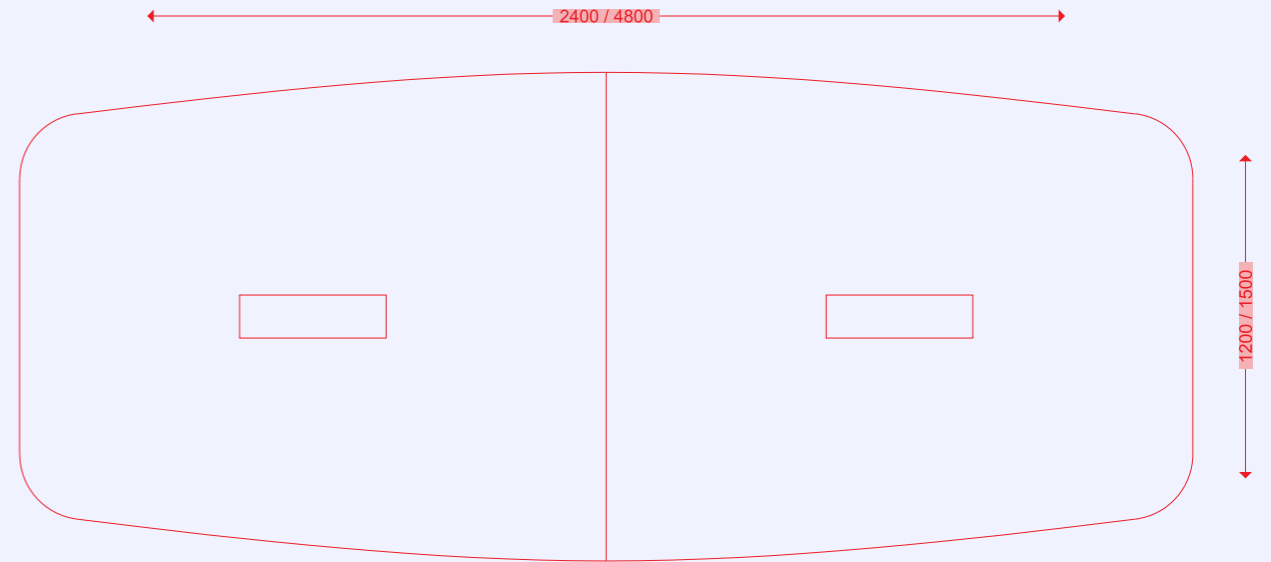

PRODUCT DESCRIPTION

WORKTOP
25MM THICK PL-PB/MDF

LEGS
25MM THICK PL-PB/MDF

MODESTY
18MM THICK PL-PB/MDF

WIRE MANAGEMENT
ALUMINIUM FLAP WITH
MS CABLE CARRIER AND RISER

CLUSTER
Amodini Workstation

STYLE
Meeting/ Conference Table

CATEGORY
A-CT-03

* Dimensions in MM

For more information visit us at:
www.amodinisystems.com

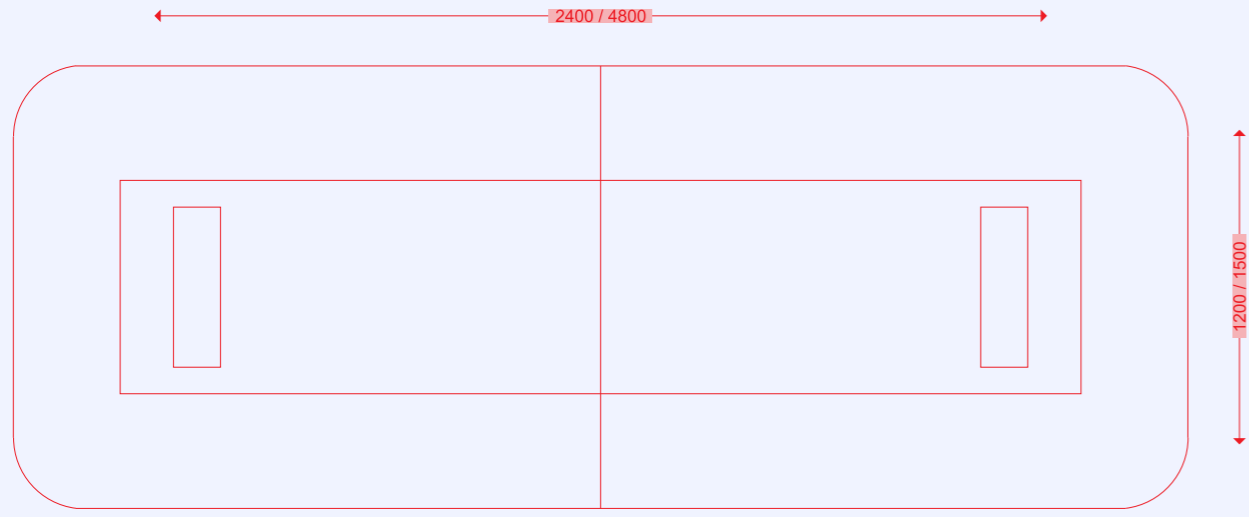

CLUSTER

Amodini Workstation

STYLE

Meeting/ Conference Table

CATEGORY

A-CT-04

PRODUCT DESCRIPTION

WORKTOP

25MM THICK PL-PB/MDF

LEGS

25MM THICK PL-PB/MDF

MODESTY

18MM THICK PL-PB/MDF

WIRE MANAGEMENT

ALUMINIUM FLAP WITH
MS CABLE CARRIER AND RISER

* Dimensions in MM

For more information visit us at:
www.amodinisystems.com

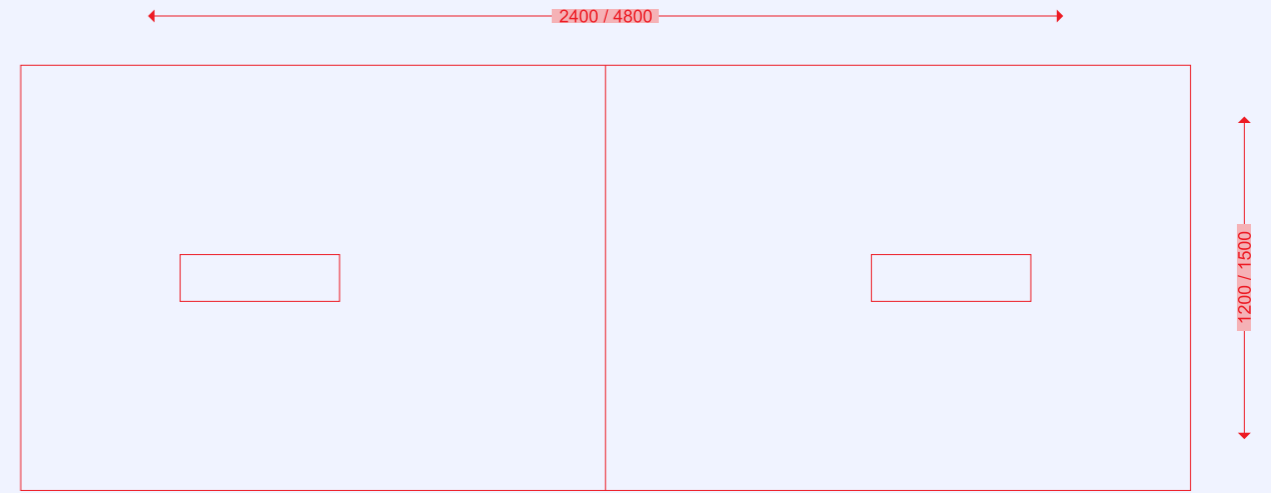

PRODUCT DESCRIPTION

WORKTOP
25MM THICK PL-PB/MDF

LEGS
25MM THICK PL-PB/MDF

MODESTY
18MM THICK PL-PB/MDF

WIRE MANAGEMENT
ALUMINIUM FLAP WITH
MS CABLE CARRIER AND RISER

CLUSTER
Amodini Workstation

STYLE
Meeting/ Conference Table

CATEGORY
A-CT-05

* Dimensions in MM

For more information visit us at:
www.amodinisystems.com

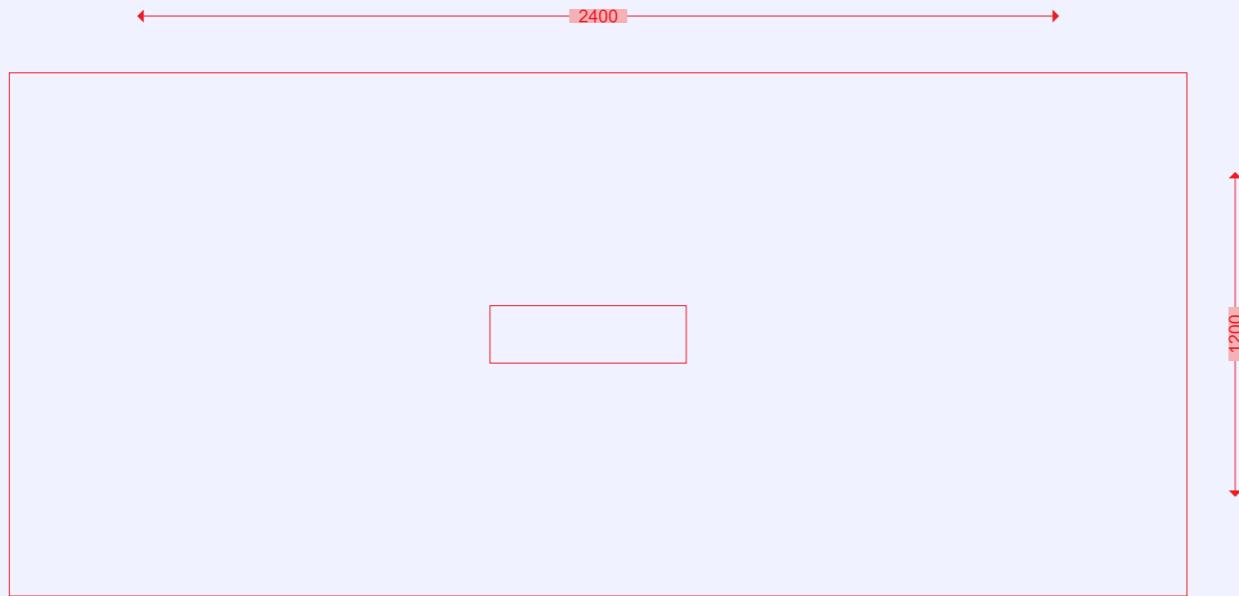

CLUSTER

Amodini Workstation

STYLE

Meeting/ Conference Table

CATEGORY

A-CT-06

PRODUCT DESCRIPTION

WORKTOP

25MM THICK PL-PB/MDF

LEGS

25MM THICK PL-PB/MDF

MODESTY

18MM THICK PL-PB/MDF

WIRE MANAGEMENT

ALUMINIUM FLAP WITH
MS CABLE CARRIER AND RISER



* Dimensions in MM

For more information visit us at:
www.amodinisystems.com

Seating

You spend more time in an office than at home being awake to be honest. For those long hours in the office you need an office chair which is ergonomic. We consider chair to be the most important furniture in an office and if chosen right it can be a blessing. At Amodini, we continuously innovate and test every piece of chair before placing it in your office.

The lumbar support, seat adjustment, arm adjustment, wheel rotation, mesh tensile strength, foam density and chair mechanism are some of the most important components when selecting an office chair. Our chairs are made using best ergonomic practices and duly tested for strength and comfort to make you work those long hours.





OPTIMA
HIGH BACK



OPTIMA
MEDIUM BACK



DUNE
HIGH BACK- ZX



DUNE
MEDIUM BACK- ZX



DUNE
MEDIUM BACK- LX



ZAP
HIGH BACK- ZX



DUNE
MEDIUM BACK- ECO



VINO
HIGH BACK- ZX



VINO
MEDIUM BACK- ZX



VINO
MEDIUM BACK- LX



VINO
MEDIUM BACK- VISITOR



JAZZ
MEDIUM BACK- ZX



ZAP
MEDIUM BACK- ZX



ZAP
MEDIUM BACK- LX



ZAP
MEDIUM BACK- VISITOR



JAZZ
MEDIUM BACK- ZX



JAZZ
MEDIUM BACK- LX



JAZZ
HIGH BACK- LX



MATRIX
HIGH BACK- SMART



MATRIX
MEDIUM BACK- SMART



JAZZ
MEDIUM BACK- SMART



JAZZ
MEDIUM BACK- ECO



JAZZ
MEDIUM BACK- VISITOR



TASK
MEDIUM BACK- ZX



TASK
MEDIUM BACK- LX



TASK
MEDIUM BACK- VISITOR



AMIGO
MEDIUM BACK- ZX



AMIGO
MEDIUM BACK- LX



AMIGO
MEDIUM BACK- VISITOR



STORM
HIGH BACK- ZX



STORM
MEDIUM BACK- ZX



STORM
HIGH BACK- LX



STORM
MEDIUM BACK- LX



STORM
MEDIUM BACK- ECO



MATRIX
HIGH BACK- ZX



MATRIX
MEDIUM BACK- ZX



MATRIX
LOW BACK- ZX



MATRIX
HIGH BACK- LX



MATRIX
MEDIUM BACK- LX



MATRIX
LOW BACK- LX



STUN
MEDIUM BACK- ZX



STUN
MEDIUM BACK- LX



MATRIX
MEDIUM BACK- ECO



TANG
MEDIUM BACK- ZX



TANG
MEDIUM BACK- LX



TANG
MEDIUM BACK- VISITOR



SLEEK
MEDIUM BACK



TOM
MEDIUM BACK



STUN
MEDIUM BACK- VISITOR



ROYAL
HIGH BACK



ROYAL
MEDIUM BACK



HARVARD
MESH TRAINING



HARVARD
TRAINING



HARVARD
VISITOR



Turnkey Interior

We have come out with some outstanding Turnkey Interior services for offices of all kinds. Under this service, we enable our corporate clients to get a nice set-up and interior from operations to the reception area in the office. All areas can be designed and furnished with good furniture and workstation made up of quality wood and steel material. All set ups can be designed precisely and can also be customized according to the client's requirement. We sum up all types of office turnkey interior projects with the help of our experts, who have years of experience in the same field. They do the world-class decoration of office interior and can make it a nice place to work and cherish.



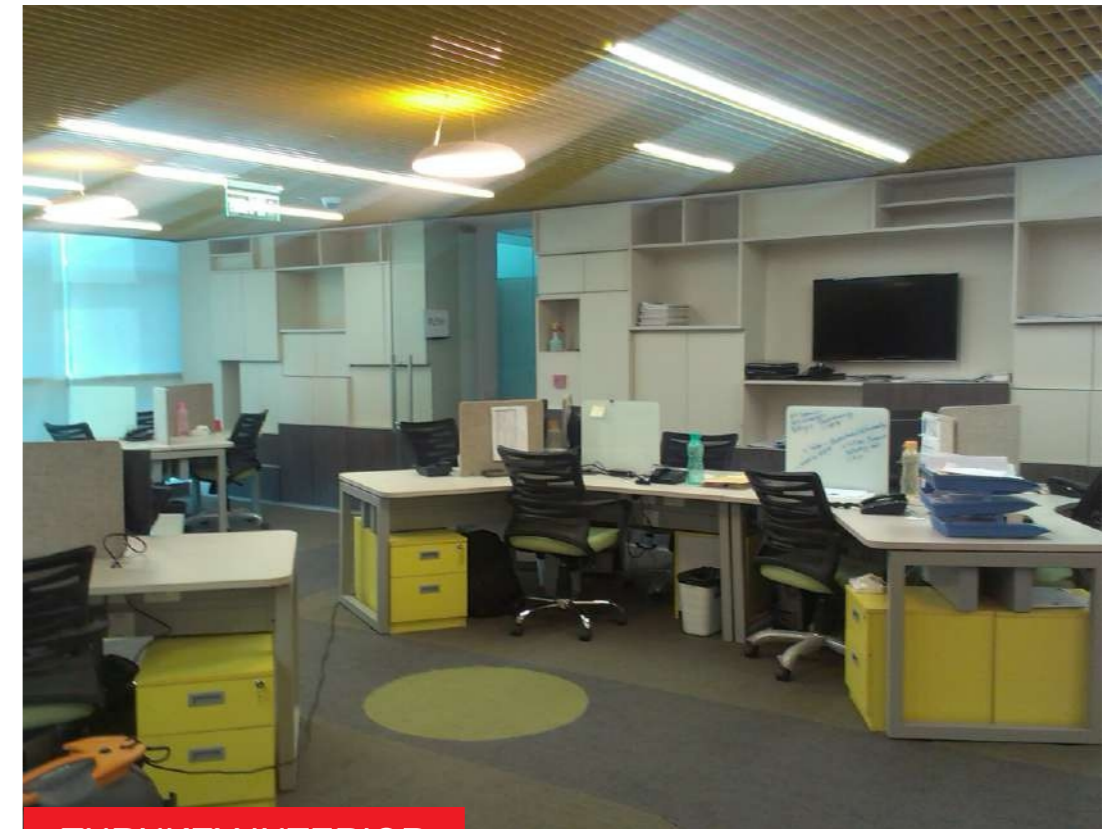

TURNKEY INTERIOR



TURNKEY INTERIOR

Certificate



Certificate of Registration

This is to certify that

AMODINI SYSTEM
 Regd. Address :- CHAMBER NO-02, SHEVALIK TOWER, KAUSHAMBI GHAZIABAD UP-201012
 Factory Address :- 33/12, SITE-2 INDUSTRIAL AREA, NEAR- HARSHA COMPOUND, LONI ROAD, MOHAN NAGAR, GHAZIABAD UP-201007

has been independently assessed by QRO and is compliant with the requirements of:

ISO 9001:2015
Quality Management System

For the following scope of activities:

MANUFACTURING AND SUPPLIER OFFICE TABLES, WORKSTATION TABLES, CONFERENCE TABLE, MD TABLES, EXECUTIVE TABLES, RECEPTION TABLE, CHAIRS, INSTITUTIONAL FURNITURE, MODULAR TOILET, CUBIC POSITION, METAL STORAGE, DRAWERS

Date of Certification: 28th January 2020 2nd Surveillance Audit Due: 27th January 2022
 1st Surveillance Audit Due: 27th January 2021 Certificate Expiry: 27th January 2023

Certificate Number: Draft



Head of Certification

Validity of this certificate is subject to annual surveillance audits to be done successfully on or before 365 days from date of the audit. In case if surveillance audit is not allowed to be conducted, this certificate shall be suspended / withdrawn.
 The Validity of this certificate can be verified at www.qroert.org
 This certificate of registration remains the property of QRO Certification LLP, and shall be returned immediately upon request.

India Office : QRO Certification LLP
 142, 1st Floor, Avtar Enclave, Near Panchs Vihar West Metro Station, Delhi-110063, (INDIA)
 Website : www.qroert.org, E-mail : info@qroert.org



Certificate of Registration

This is to certify that

AMODINI SYSTEM
 Regd. Address:- CHAMBER NO-02, SHEVALIK TOWER, KAUSHAMBI GHAZIABAD UP-201012
 Factory Address:- 33/12, SITE-2 INDUSTRIAL AREA, NEAR- HARSHA COMPOUND, LONI ROAD, MOHAN NAGAR, GHAZIABAD UP-201007

has been independently assessed by QRO and is compliant with the requirements of:

ISO 14001:2015
Environmental Management System

For the following scope of activities:

MANUFACTURING AND SUPPLIER OFFICE TABLES, WORKSTATION TABLES, CONFERENCE TABLE, MD TABLES, EXECUTIVE TABLES, RECEPTION TABLE, CHAIRS, INSTITUTIONAL FURNITURE, MODULAR TOILET, CUBIC POSITION, METAL STORAGE, DRAWERS

Date of Certification: 28th January 2020 2nd Surveillance Audit Due: 27th January 2022
 1st Surveillance Audit Due: 27th January 2021 Certificate Expiry: 27th January 2023

Certificate Number: Draft



Head of Certification

Validity of this certificate is subject to annual surveillance audits to be done successfully on or before 365 days from date of the audit. In case if surveillance audit is not allowed to be conducted, this certificate shall be suspended / withdrawn.
 The Validity of this certificate can be verified at www.qroert.org
 This certificate of registration remains the property of QRO Certification LLP, and shall be returned immediately upon request.

India Office : QRO Certification LLP
 142, 1st Floor, Avtar Enclave, Near Panchs Vihar West Metro Station, Delhi-110063, (INDIA)
 Website : www.qroert.org, E-mail : info@qroert.org



Certificate of Compliance

This is to certify that

AMODINI SYSTEM
 Regd. Address:- CHAMBER NO-02, SHEVALIK TOWER, KAUSHAMBI GHAZIABAD UP-201012
 Factory Address:- 33/12, SITE-2 INDUSTRIAL AREA, NEAR- HARSHA COMPOUND, LONI ROAD, MOHAN NAGAR, GHAZIABAD UP-201007

Product

OFFICE TABLES, WORKSTATION TABLES, CONFERENCE TABLE, MD TABLES, EXECUTIVE TABLES, RECEPTION TABLE, CHAIRS, INSTITUTIONAL FURNITURE, MODULAR TOILET, CUBIC POSITION, METAL STORAGE, DRAWERS

Has been independently assessed and found as meeting the requirements of Compliance of sustainability standard as per

BIFMA

This certificate is issued under the following conditions:

- It applies only to the quality system maintained in the manufacture of above referenced models and it does not substitute the design or type examination procedures, if required.
- The certificate remains valid only as long as the manufacturing conditions or the quality systems are not changed.
- The certificate validity is maintained by positive results of surveillance audits.
- The statement is based on a single evaluation of one sample of above mentioned product. It does not imply an assessment of the whole production.

Date of Certification: 20th January 2020 2nd Surveillance Audit Due: 19th January 2022
 1st Surveillance Audit Due: 19th January 2021 Certificate Expiry: 19th January 2023

Certificate Number: Draft



Head of Certification

Validity of this certificate is subject to annual surveillance audits to be done successfully on or before 365 days from date of the audit. In case if surveillance audit is not allowed to be conducted, this certificate shall be suspended / withdrawn.
 The Validity of this certificate can be verified at www.qroert.org
 This certificate of registration remains the property of QRO Certification LLP, and shall be returned immediately upon request.
 QRO Certification LLP is accredited by UK Accrediting Forum Limited, UK (www.ukaf.org.uk)
 5 Jupiter House, Colsons Park, Aldermaston, Reading Berkshire RG292N UK

India Office : QRO Certification LLP
 142, 1st Floor, Avtar Enclave, Near Panchs Vihar West Metro Station, Delhi-110063, (INDIA)
 Website : www.qroert.org, E-mail : info@qroert.org



Certificate of Registration

This is to certify that

AMODINI SYSTEM
 Regd. Address :- CHAMBER NO-02, SHEVALIK TOWER, KAUSHAMBI GHAZIABAD UP-201012
 Factory Address :- 33/12, SITE-2 INDUSTRIAL AREA, NEAR- HARSHA COMPOUND, LONI ROAD, MOHAN NAGAR, GHAZIABAD UP-201007.

has been independently assessed by QRO and is compliant with the requirements of:

ISO 45001:2018
Occupational health and safety

For the following scope of activities:

MANUFACTURING AND SUPPLIER OFFICE TABLES, WORKSTATION TABLES, CONFERENCE TABLE, MD TABLES, EXECUTIVE TABLES, RECEPTION TABLE, CHAIRS, INSTITUTIONAL FURNITURE, MODULAR TOILET, CUBIC POSITION, METAL STORAGE, DRAWERS

Date of Certification: 28th January 2020 2nd Surveillance Audit Due: 27th January 2022
 1st Surveillance Audit Due: 27th January 2021 Certificate Expiry: 27th January 2023

Certificate Number: Draft



Head of Certification

Validity of this certificate is subject to annual surveillance audits to be done successfully on or before 365 days from date of the audit. In case if surveillance audit is not allowed to be conducted, this certificate shall be suspended / withdrawn.
 The Validity of this certificate can be verified at www.qroert.org
 This certificate of registration remains the property of QRO Certification LLP, and shall be returned immediately upon request.

India Office : QRO Certification LLP
 142, 1st Floor, Avtar Enclave, Near Panchs Vihar West Metro Station, Delhi-110063, (INDIA)
 Website : www.qroert.org, E-mail : info@qroert.org



Certificate of Compliance

This is to certify that

AMODINI SYSTEM
 Regd. Address :- CHAMBER NO-02, SHEVALIK TOWER, KAUSHAMBI GHAZIABAD UP-201012
 Factory Address :- 33/12, SITE-2 INDUSTRIAL AREA, NEAR- HARSHA COMPOUND, LONI ROAD, MOHAN NAGAR, GHAZIABAD UP-201007.

GREENGUARD COMPLIANCE

For low emitting products and materials under the standards of the institute for the following scope:

MANUFACTURING AND SUPPLIER OFFICE TABLES, WORKSTATION TABLES, CONFERENCE TABLE, MD TABLES, EXECUTIVE TABLES, RECEPTION TABLE, CHAIRS, INSTITUTIONAL FURNITURE, MODULAR TOILET, CUBIC POSITION, METAL STORAGE, DRAWERS

We hereby confirm that the technical file for above mentioned commercial building product as produced to us comply with the essential requirements. In case of alteration of the raw materials used for manufacturing of commercial building product, not agreed upon by us, this declaration will lose its validity. This statement is based on a random evaluation of sample of above mentioned raw material. The Compliance Certificate issued as per given documents & information by the Organization.

Date of Certification: 17th September 2019 2nd Surveillance Audit Due: 16th September 2021
 1st Surveillance Audit Due: 16th September 2020 Certificate Expiry: 16th September 2022

Certificate Number: XXXXX



Head of Certification

Validity of this certificate is subject to annual surveillance audits to be done successfully on or before 365 days from date of the audit. In case if surveillance audit is not allowed to be conducted, this certificate shall be suspended / withdrawn.
 The Validity of this certificate can be verified at www.qroert.org
 This certificate of registration remains the property of QRO Certification LLP, and shall be returned immediately upon request.
 QRO Certification LLP is accredited by UK Accrediting Forum Limited, UK (www.ukaf.org.uk)
 5 Jupiter House, Colsons Park, Aldermaston, Reading Berkshire RG292N UK

India Office : QRO Certification LLP
 142, 1st Floor, Avtar Enclave, Near Panchs Vihar West Metro Station, Delhi-110063, (INDIA)
 Website : www.qroert.org, E-mail : info@qroert.org

Proudly Supplied to:

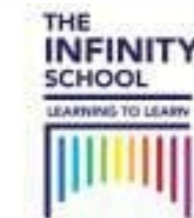
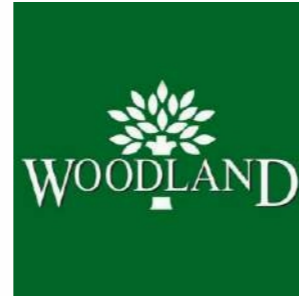



AMODINI SYSTEM



Chamber No. 2,
Shivalik Tower, Kaushambi,
Opposite Pacific Mall, Ghaziabad 201012



raj@amodinisystems.com



www.amodinisystems.com



+91-9811279994/5/7/8 |
0120-4916258



+91-9811279994

